



()

2004.12.

l.

l.

l.

l. -

l.





•

—

•

•

•

가

—

/

/

/

/

(Beer Umbrella)

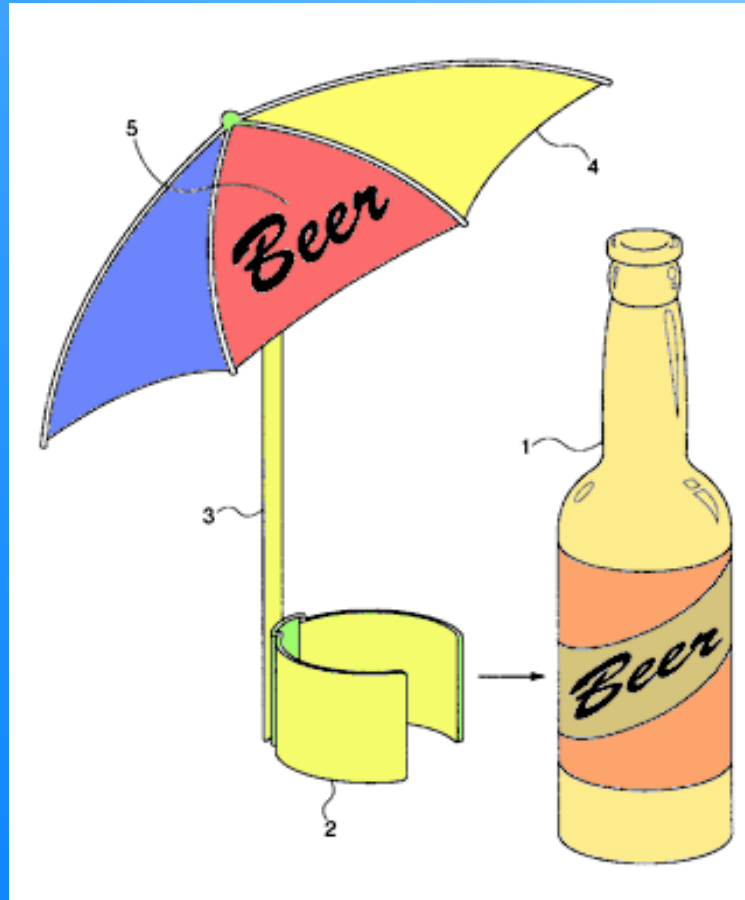

(?)

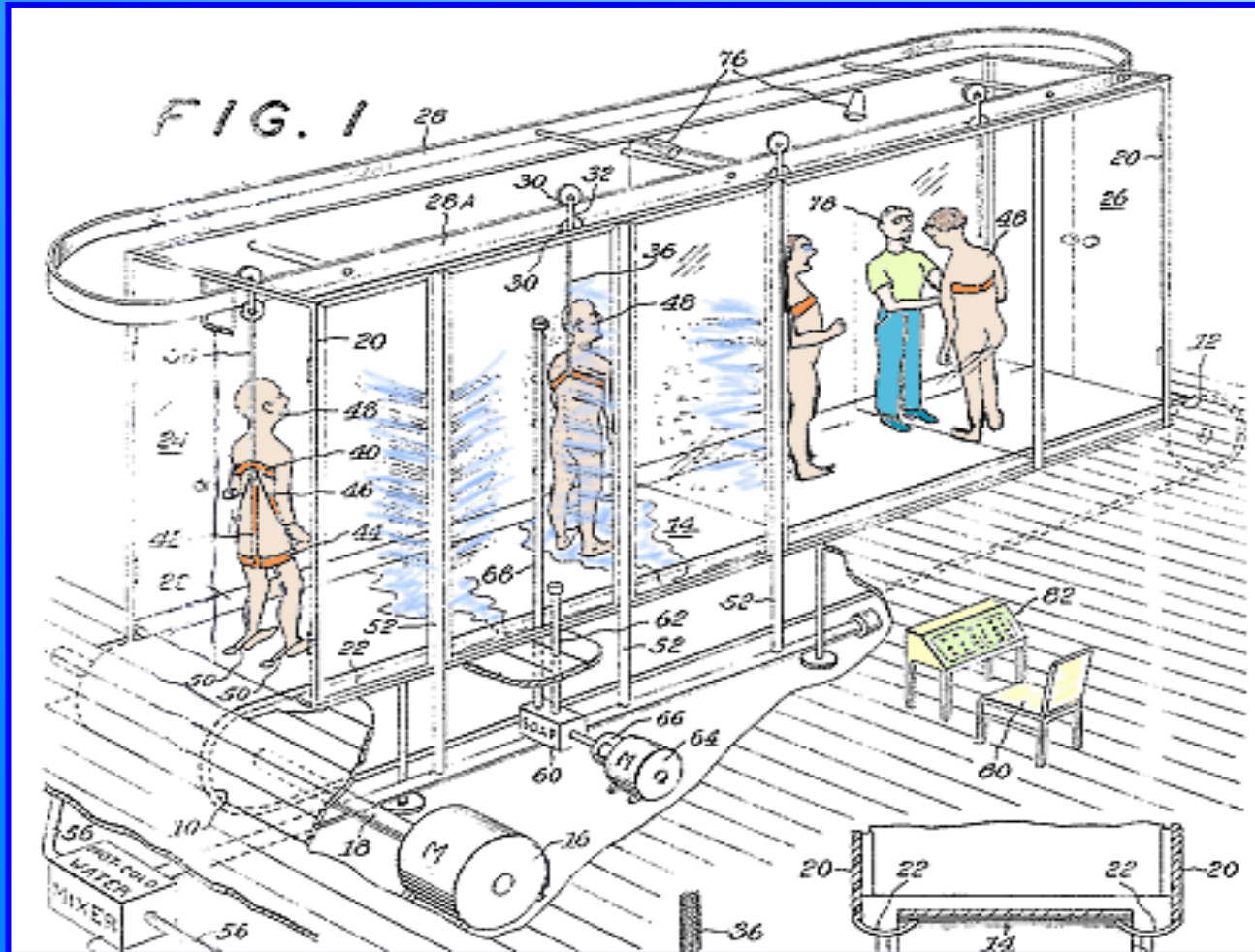

(US 5,713,081)



•

:

가

,

가

-

-

가

가

3

가

.



2 /

-
- 가 ()
-
- =?



(가)

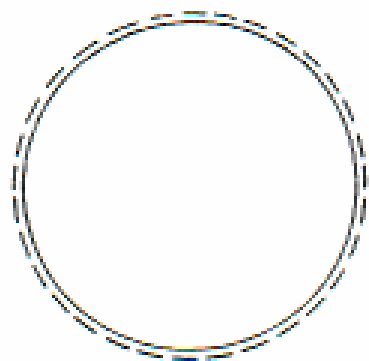

(나)

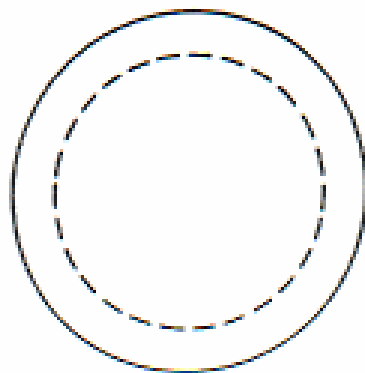

(다)



그림 1

() -



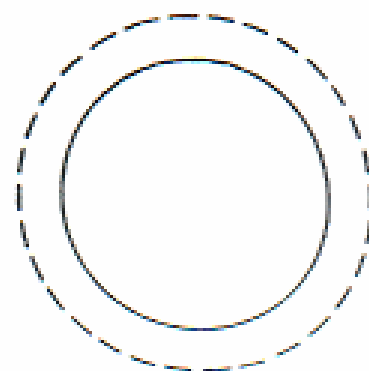
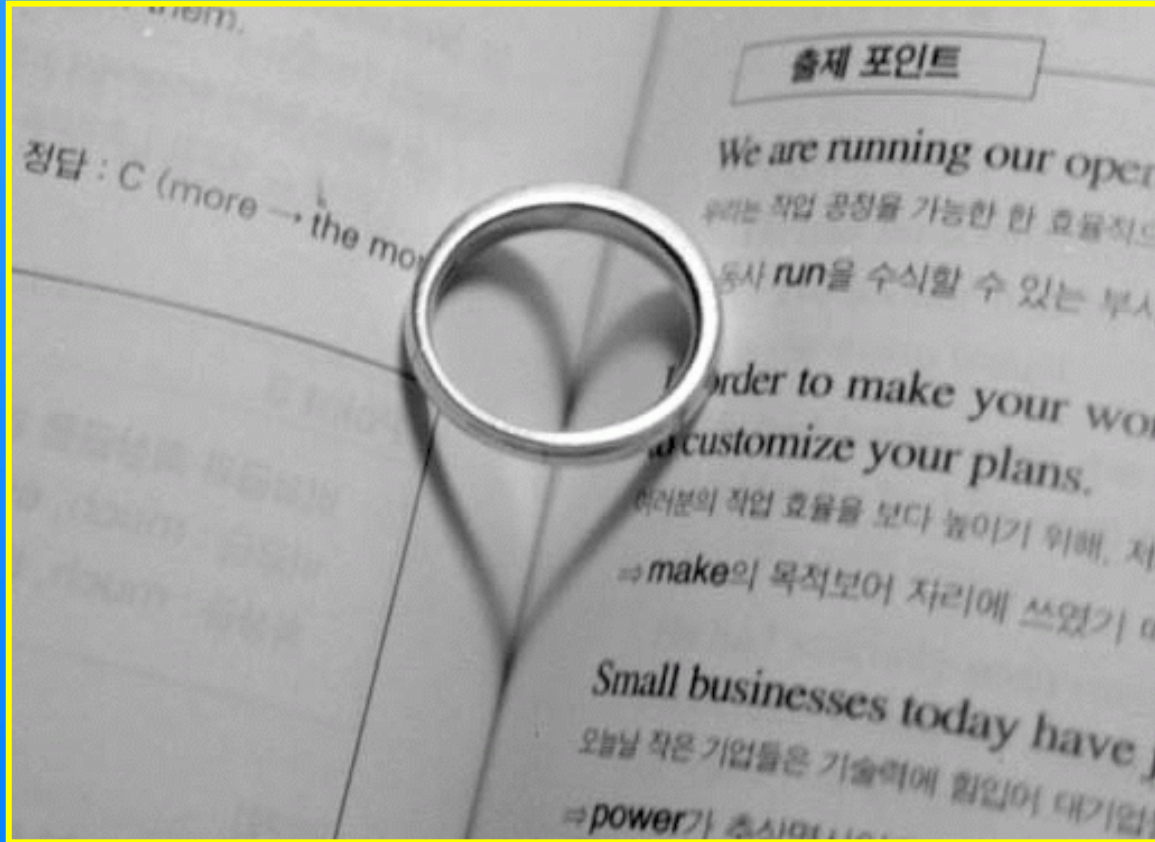

■

⋮

■

⋮

■

⋮

,

가
가

●

“

”

가

.

● 2

—

,

,

,

—

“

”

가

.

- - A, B, C
 - A, B, C
 - A, B, C

- - _____ 2
 -

C

1. A B

C

,

(1) X

(2) D

(3) 100 ~ 200oC,

50 ~ 70

C

(P1019990012778)

- 1. () (Poly(butylene terephthalate)) 49.6
84.6 %, 15
50 %
0.4 %

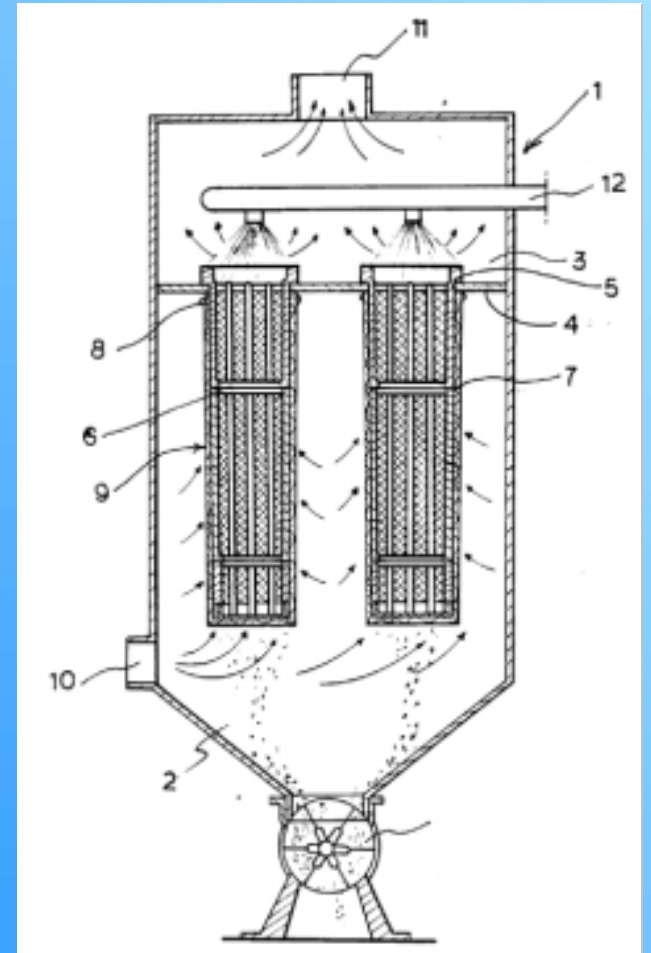

- 1. 가

• 1. Tg 가 , 가

• 1. 5 60 95 40 , (I) 0.1 20

• 1. 가 , 2 가 ,

E'가

$$1.00 \times 10^5 (\text{dyne/cm}^2)$$

• 1. 1 가 ;

1 1 가

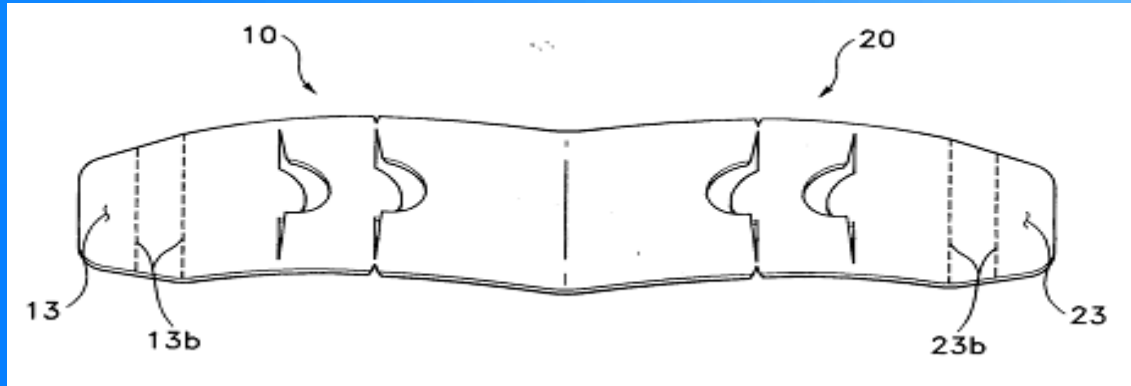

(PDA)

- 1. PDA 가 PDA
- 2. PDA 가 PDA
- 3. PDA 가 PDA

- 1. 가 :
 $\text{C(O)NR}_{12}\text{R}_{13}$, -C(O)R_8 , $\text{-NR}_9\text{R}_{10}$, $\text{-S(O)}_2\text{NR}_9\text{R}_{10}$, $\text{-SO}_2\text{R}_{14}$, $\text{-NR}_9\text{R}_{10}$, $\text{-NR}_9\text{C(O)R}_{10}$, -C(O)R_8 , $\text{-NR}_{15}\text{R}_{16}$, R_{15} , R_{16} , R_3 , R_4 , R_5 , R_6 , R_7 , R_9

R8
R10

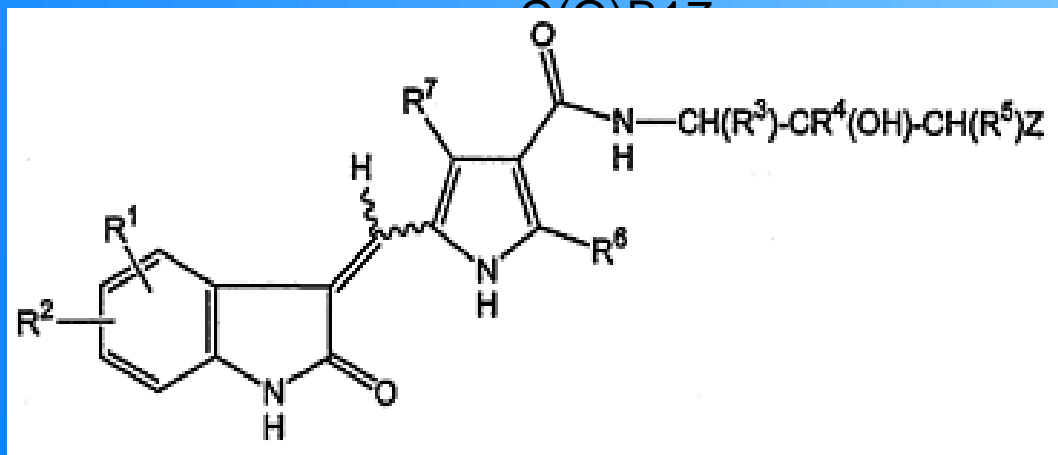

•

,

.

•

가

1.

가

,

.

•

1.

,

,

1

;

2

;

,

3

.

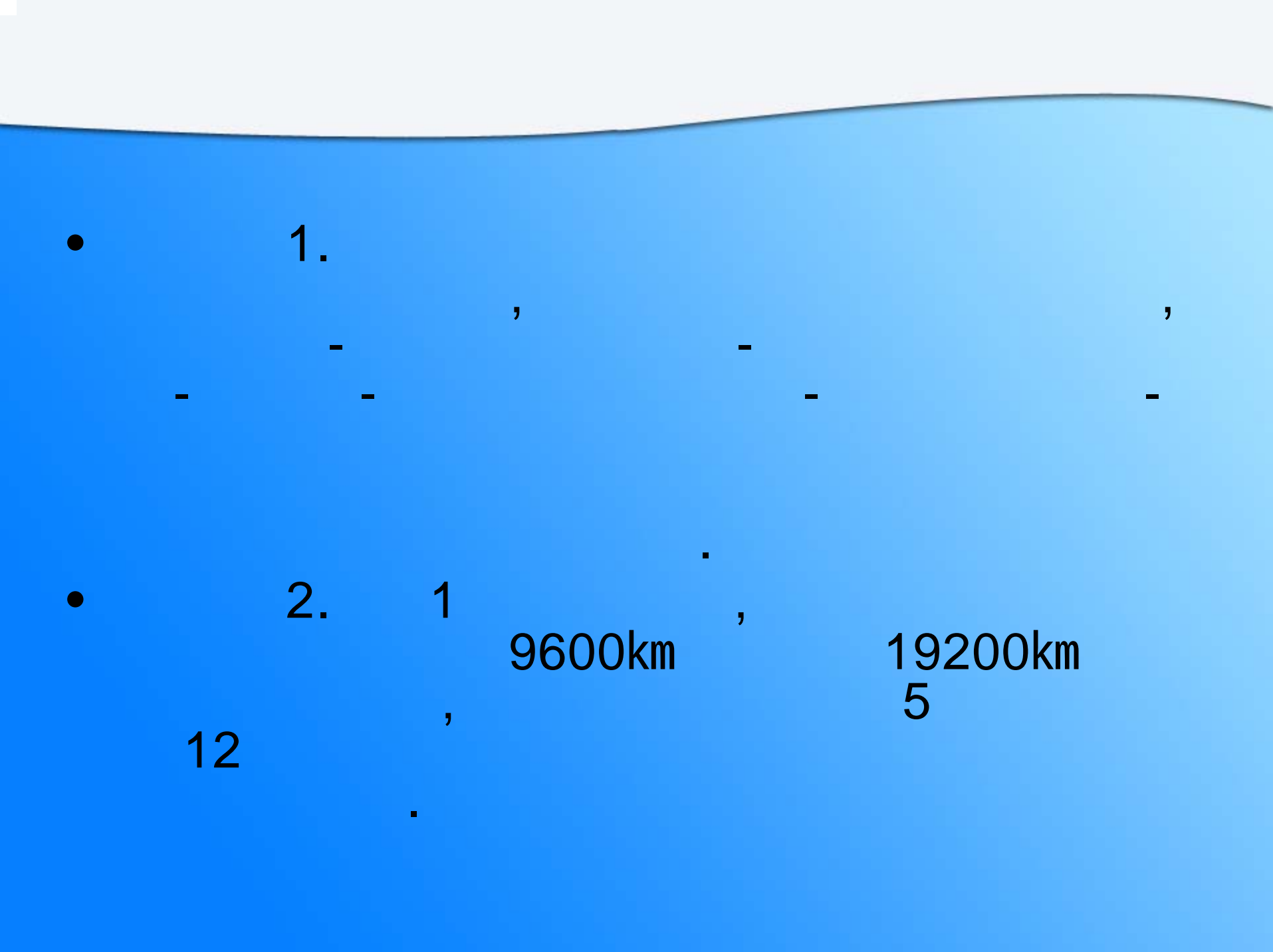

• 1. , ,
- - - -

• 2. 1 ,
9600km 19200km
12 , 5
.

• 1.

(1S-)-4-(3,4-)-1,2,3,4-
-N- -1-

가

.

• 가 (I) ,

,

• 1. 가 (I) , .

(PM.890)

· (가)
6 (,)
가, 2 가
·
가 , 가
· / (2)
가 .
· 1.
·

Dog Watch

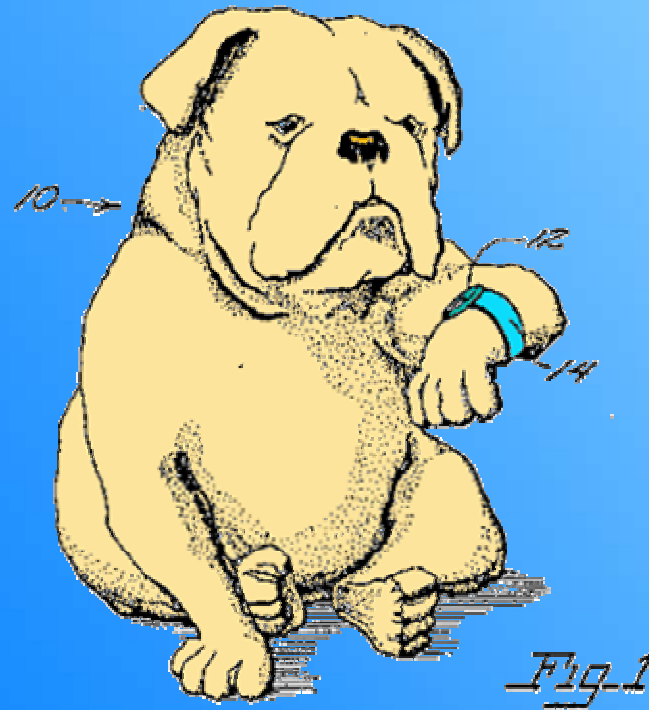



- :

- ,

-

- 가

- :
- ,
- (
-)

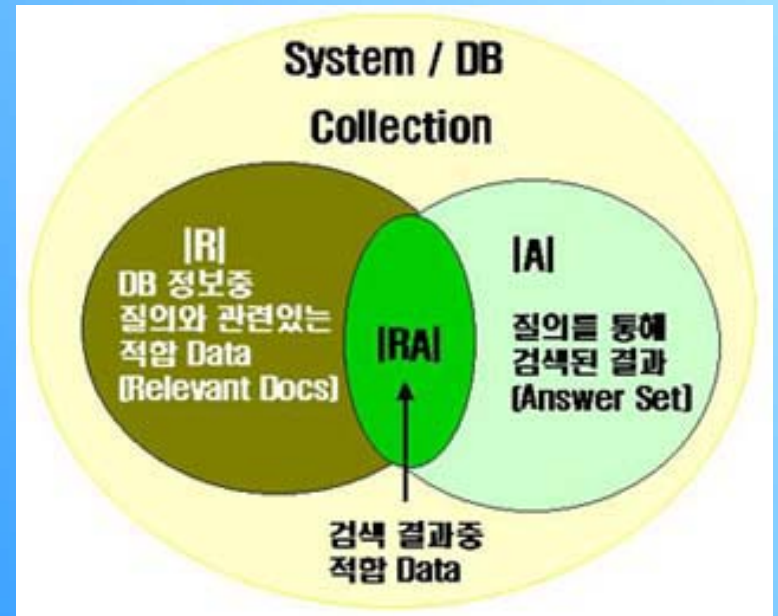

PDP

(1)

- PDP
- LG 가
- PDP TV 40 TV 24 50
- 80% 가
- 가 TV= PDP PDP
- 2 가 LG PDP
- 4 가 PDP
- 4 SDI PDP

PDP

(2)

- LG

"PDP

가

가
가

가

" "

"

- PDP

' '

- LG

4

PDP

100

SDI

SDI

400

가

가 5

9

2

- LG

SDI

6

- ?

- www.kipris.or.kr
- www.google.co.kr

-

-

-

1 :

-

2 : 가

🔍 DC-R2227DCR



(P1019990018825)

•

,

,

·

;

·

;

가

,

·

- 가 (88.10.11. , 87 197)

- ,

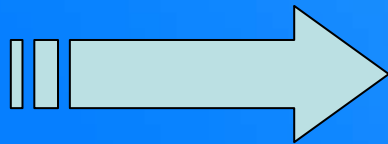

A. CLASSIFICATION OF SUBJECT MATTER

IPC(6) : A43C 15/00, 15/10; B60C 27/00, 27/06, 27/10, 27/12
 US CL : 36/7.6, 59R, 62; 152/208, 217, 221, 222

According to International Patent Classification (IPC) or to both national classification and IPC

B. FIELDS SEARCHED

Minimum documentation searched (classification system followed by classification symbols)

U.S. : 36/7.6, 59R, 62; 152/208, 217, 221, 222

Documentation searched other than minimum documentation to the extent that such documents are included in the fields searched

Electronic data base consulted during the international search (name of data base and, where practicable, search terms used)

C. DOCUMENTS CONSIDERED TO BE RELEVANT

Category*	Citation of document, with indication, where appropriate, of the relevant passages	Relevant to claim No.
Y	US 5,315,768 A (PACHECO) 31 May 1994, see entire document	1-17, 20
Y	US 4,304,280 A (LEW) 08 December 1981, see entire document	1-15, 18-19, 21-22
Y	US 3,616,552 A (KNIFFIN) 02 November 1971, see entire document	1-17, 20
Y	US 3,431,961 A (PFOERTNER) 11 March 1969, see entire document	1-15, 18-19, 21-22
Y	US 3,359,659 A (SMOLNIK) 26 December 1967, see entire document	1-17, 20
Y	US 2,252,027 A (PASQUARELLA, JR) 12 August 1941, see entire document	1-15, 18-19, 21-22

Further documents are listed in the continuation of Box C.

See patent family annex.

* Special categories of cited documents:

A document defining the general state of the art which is not considered to be of particular relevance

T

later document published after the international filing date or priority date and not in conflict with the application but cited to understand the principle or theory underlying the invention

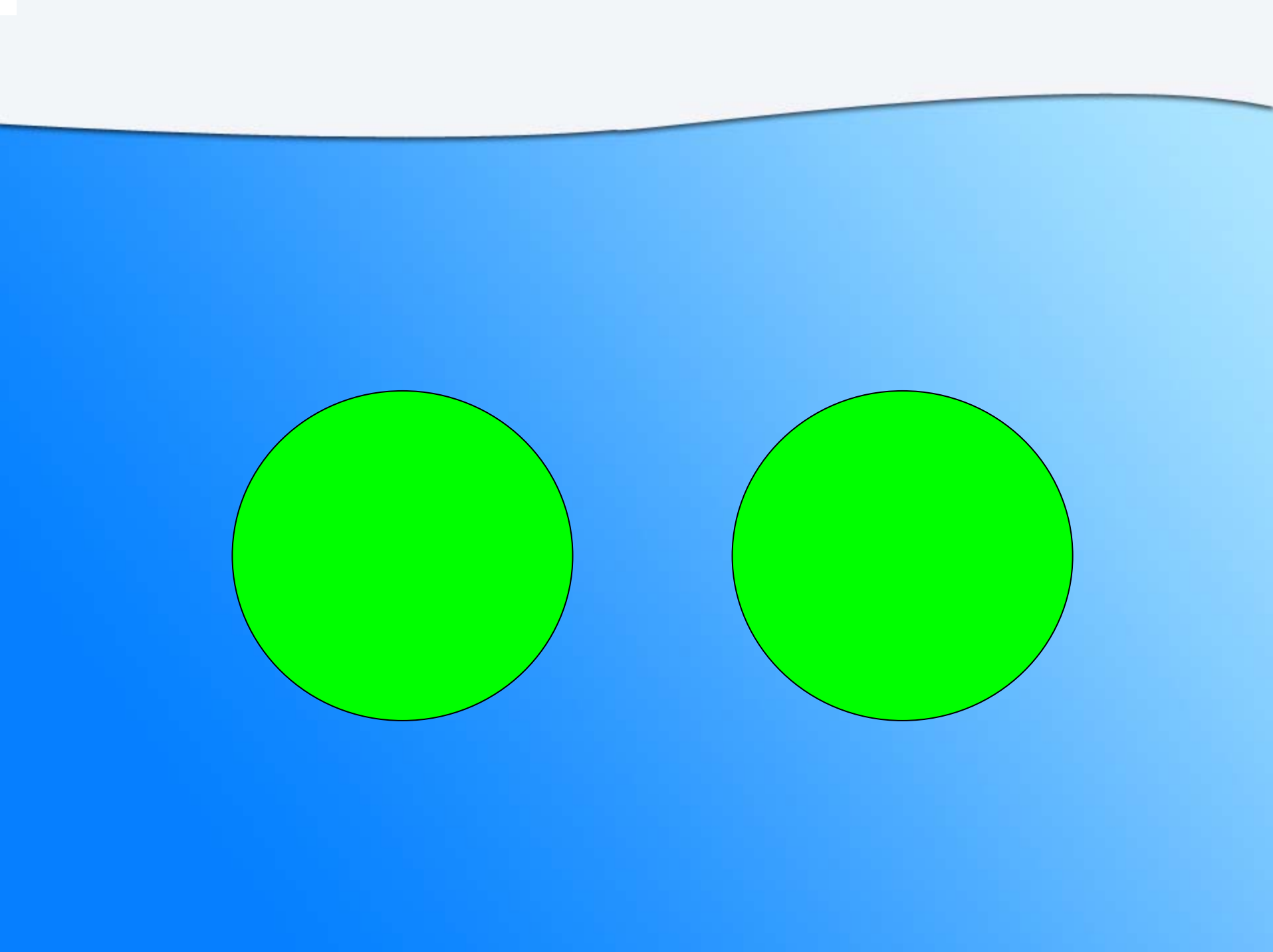

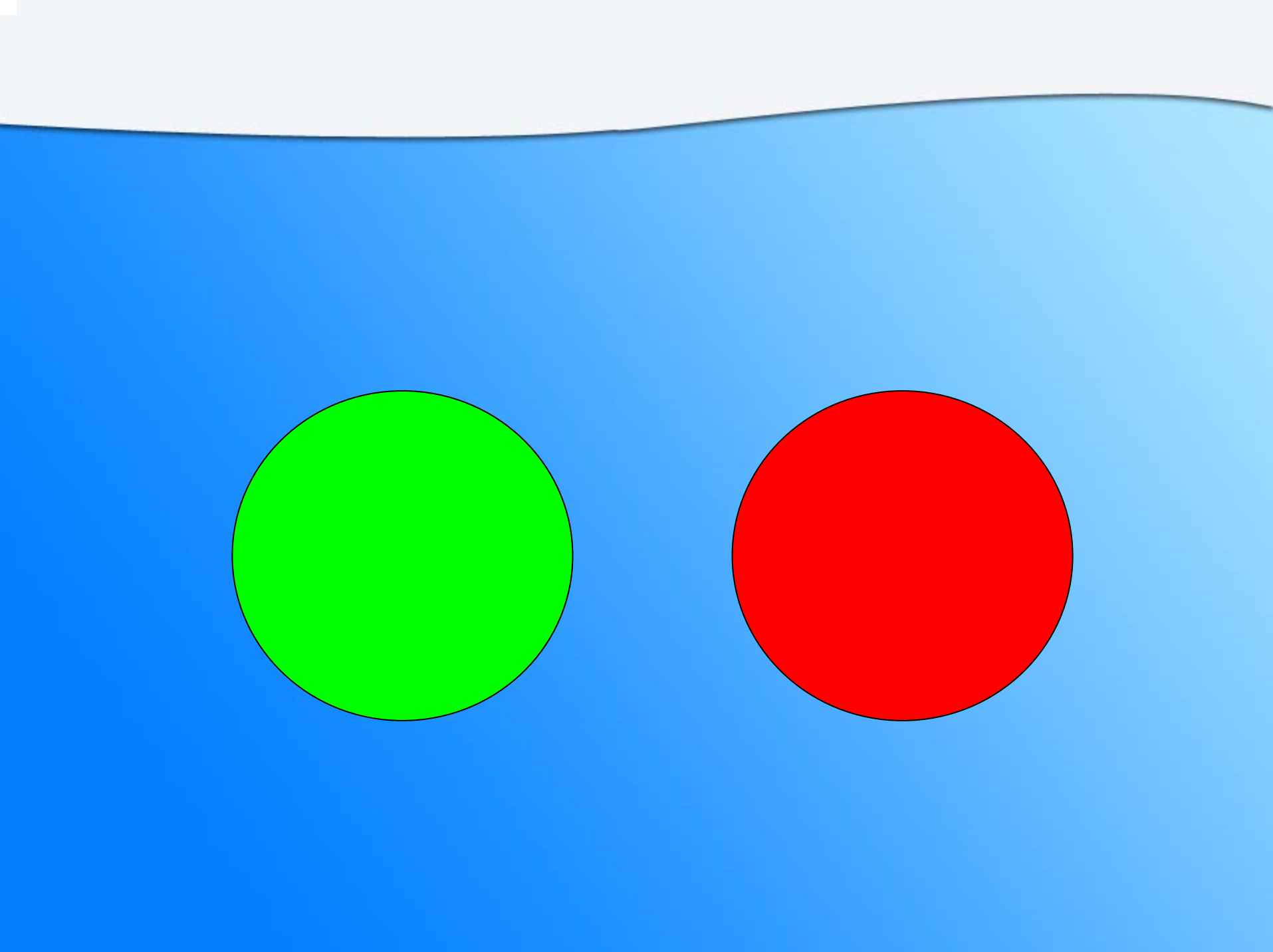

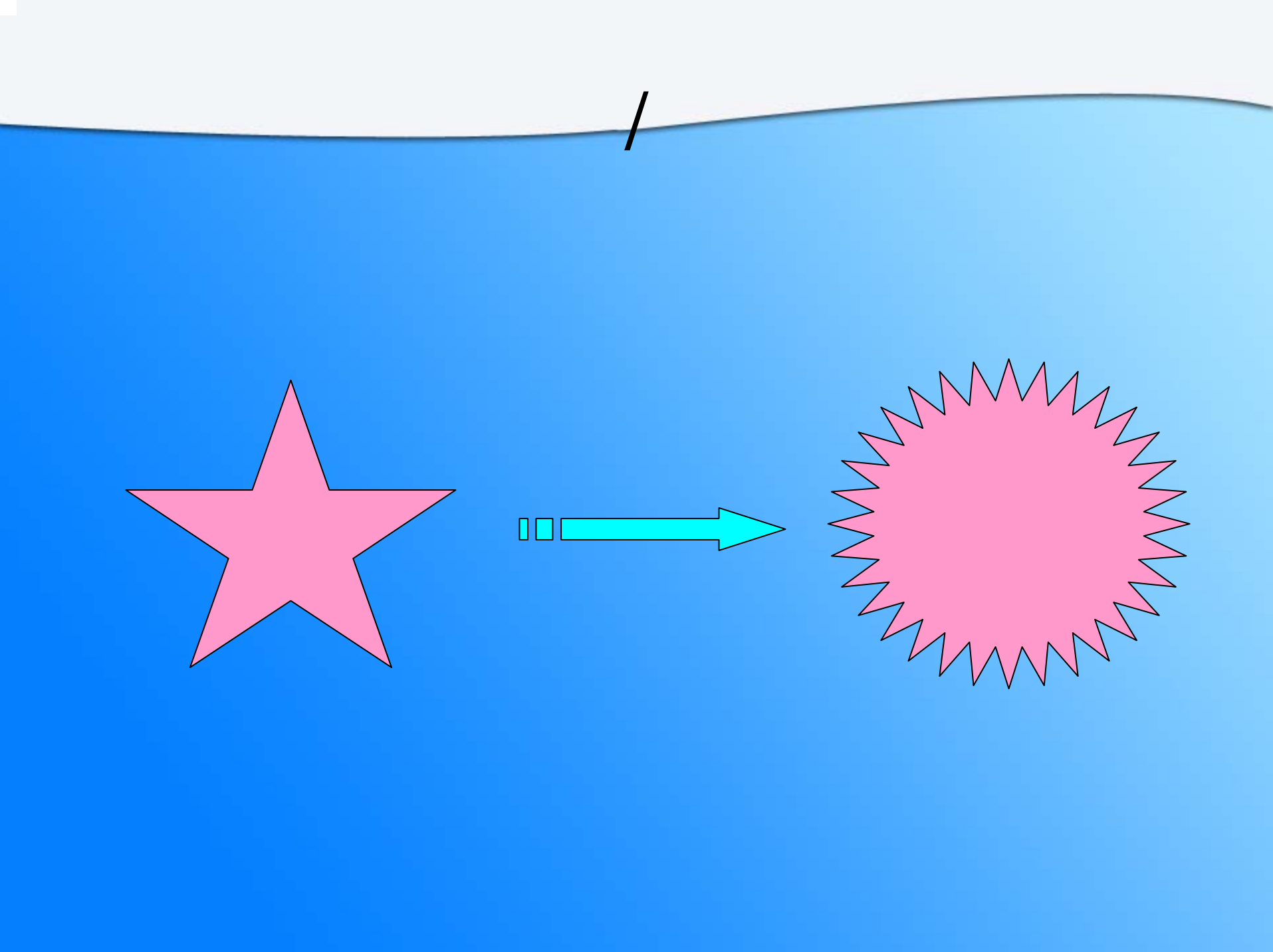

/

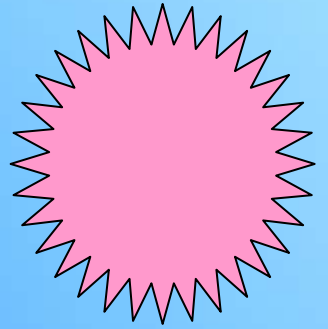
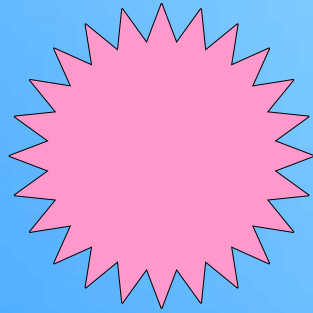
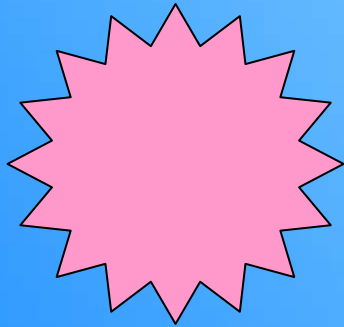
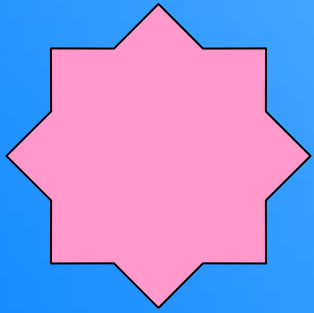

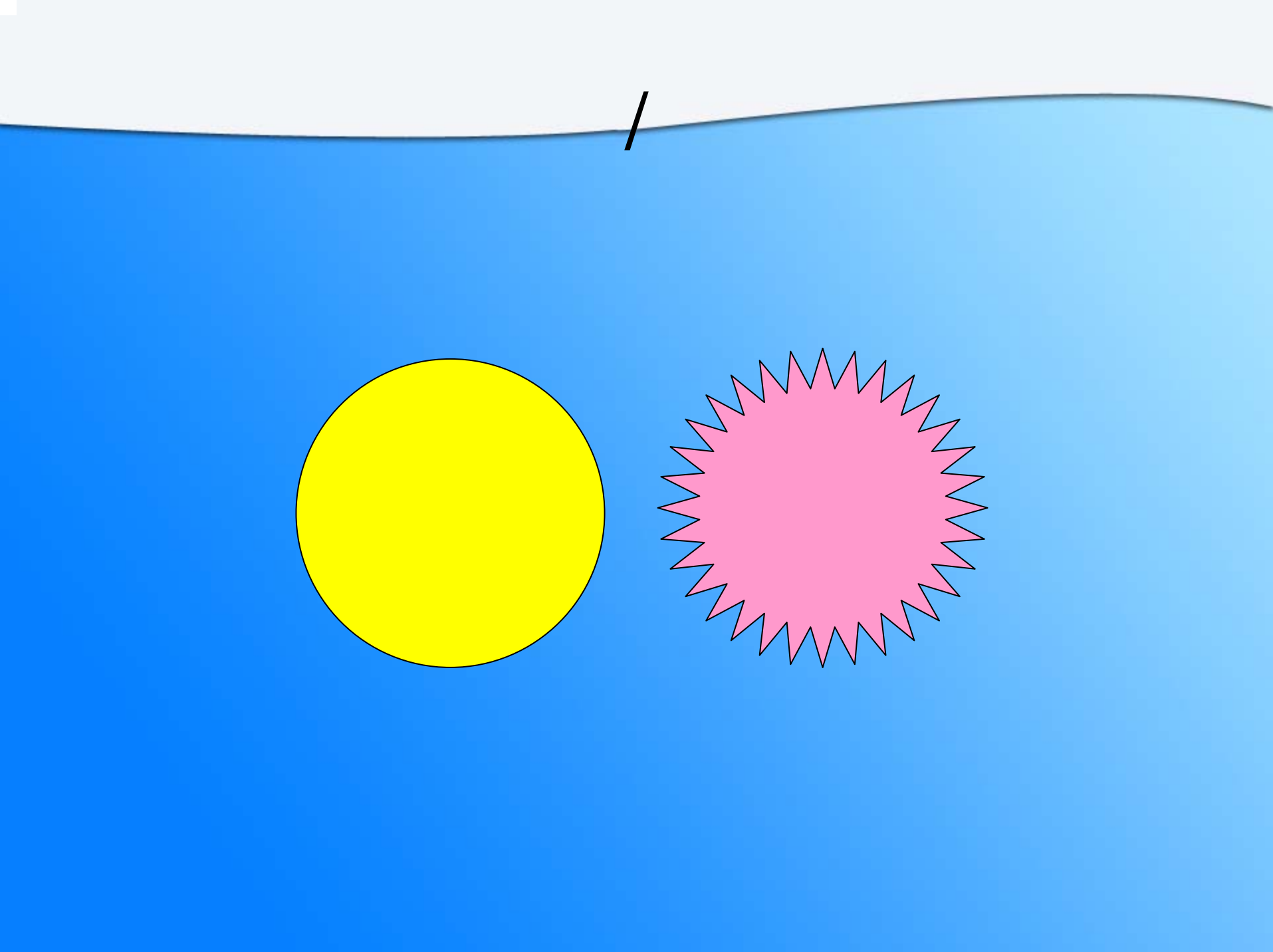

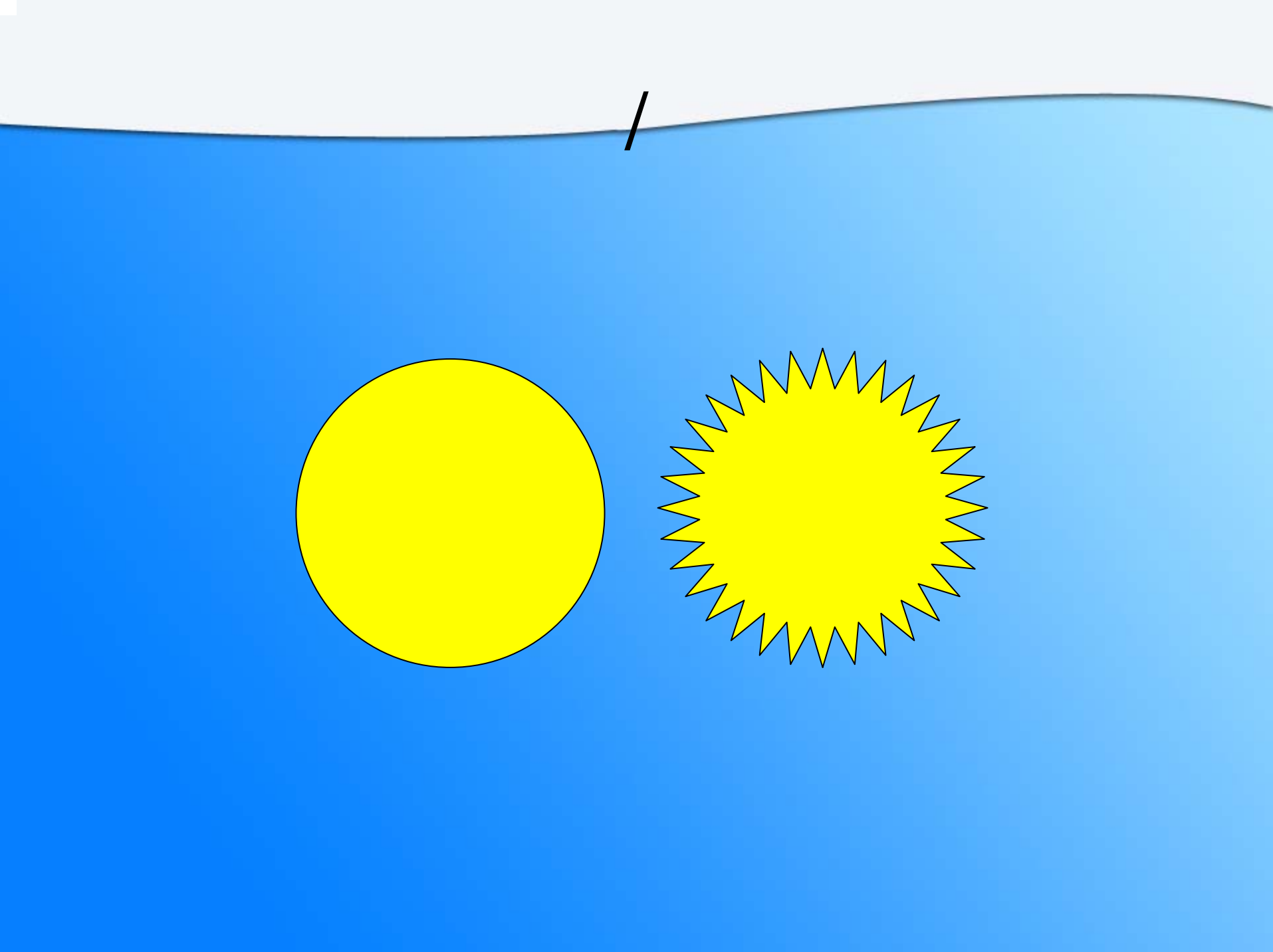

1.

2.

3.

4.

.

가,

가

가

●

· ,

●

·

· ,

●

가

·

1

●

:

·

1 :

가

·

2 :

2

• 가

:

가

•

1 :

가

가

•

2 :

가

(20 - 1999 - 2180)

- 1. 가 (17)가

(10) ,

(10) 가

1, 2 3

(13,14,15) ,

(10)

1, 2

3 (13,14,15)

(16)

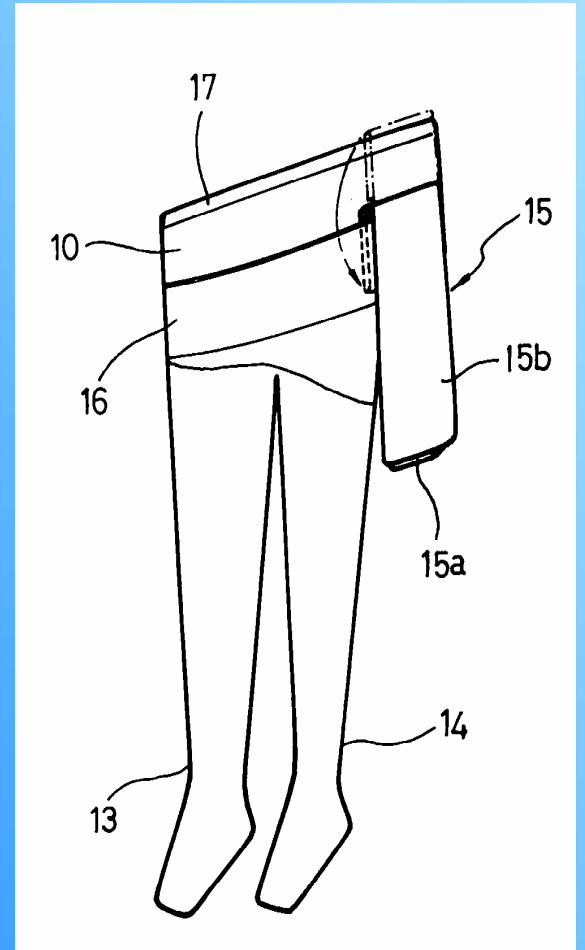

(20 - 1999 - 27622)

• 1. 가

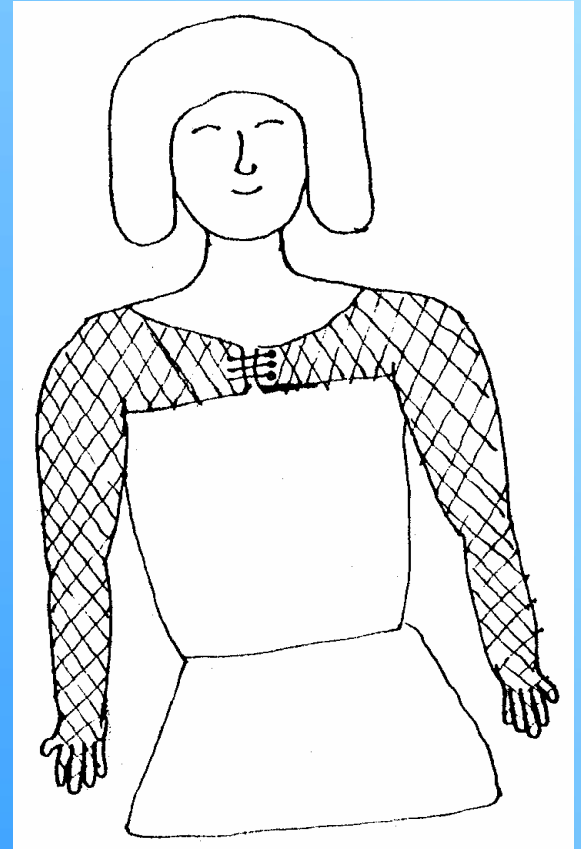

(20 - 2000 - 28255)

1.

(1)

,

(1)

(2)

(3)

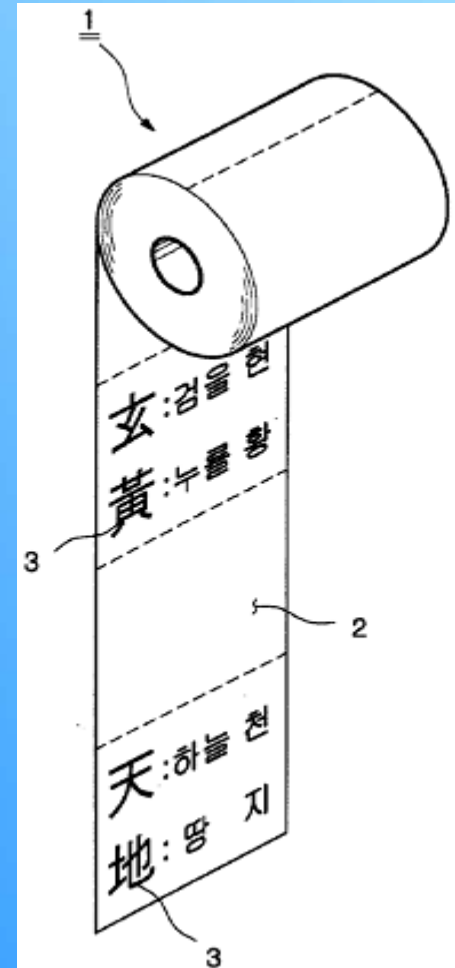

Search Report

- X :

- Y :

- A : X Y ,

()

- 1. PET , ABS , (INJECTION)

(PREFORM)

; (pitcher)
가 ; 가

()

(BLOW)

— —

.

()

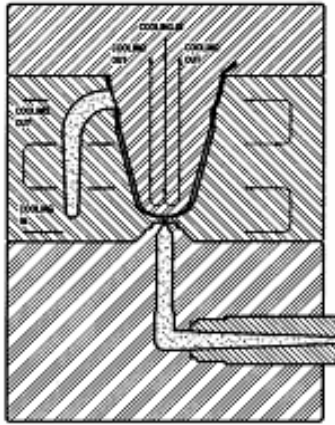

(프리폼을 성형하기 위해 수지를 주입하는 공정)

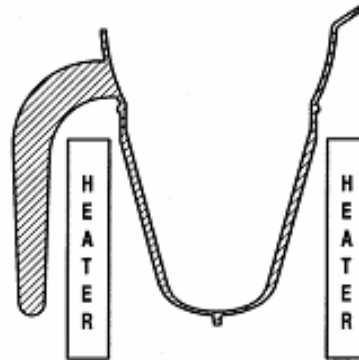

(프리폼 예열(가열)공정)

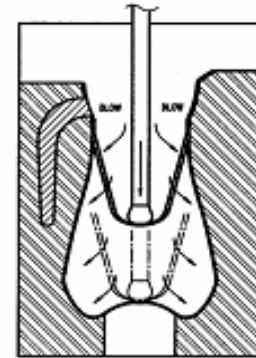

(프리폼을 연신봉으로 연신하여 성형하는 공정)

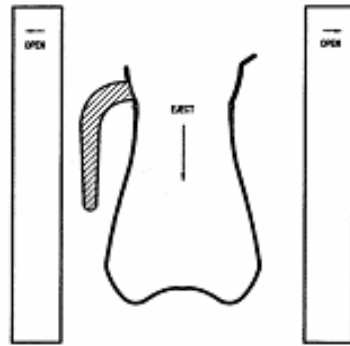

(형틀에서 탈형 공정)



(피처용기 완성)

(X, Y, A, E)

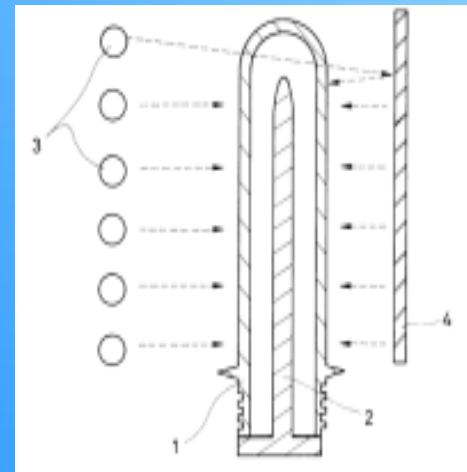
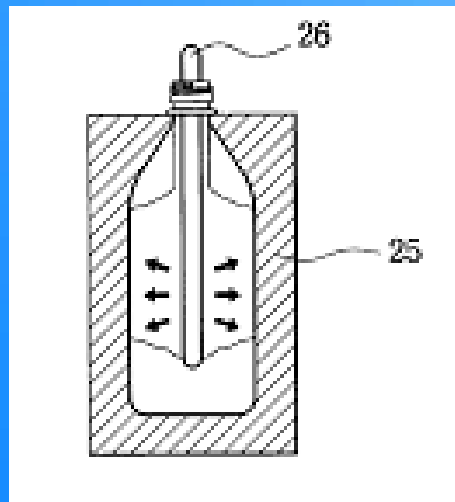
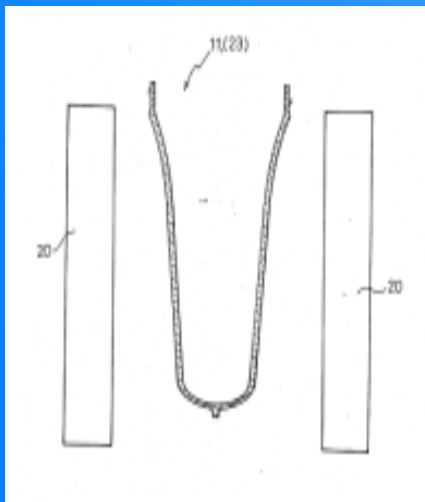
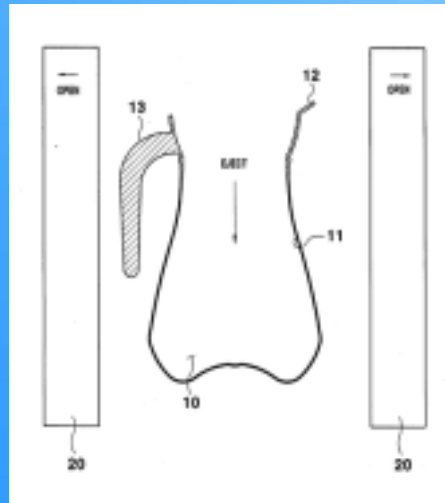

현재날씨

예보

🕒 12월 19일 21시 현재

🕒 3시간예보

서울·경기

서울

12월 19일 18시 10분

아이콘을 클릭하시면 3시간예보를 보실 수 있습니다.

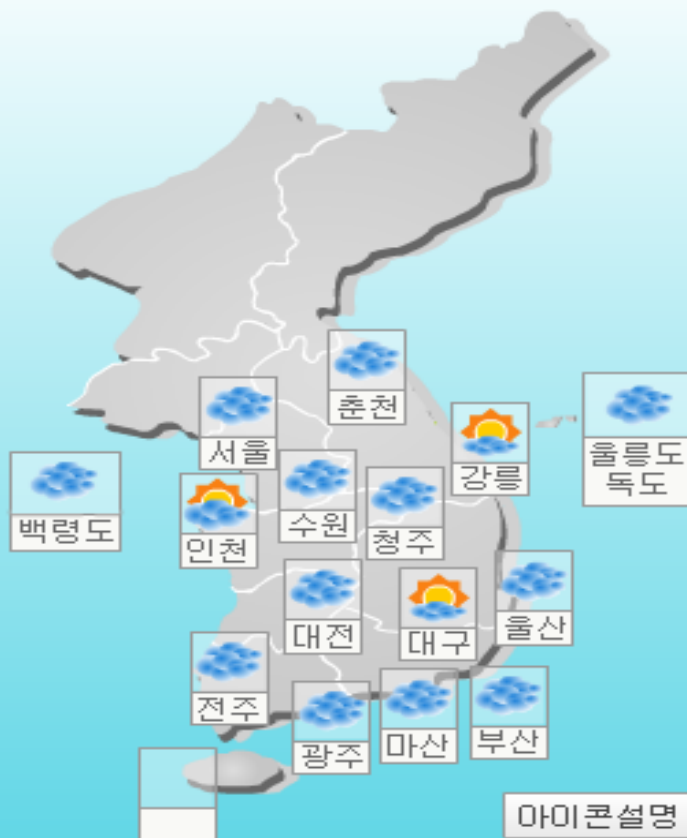

시간	19(일)	12월 20일(월)						
	21~00	00~03	03~06	06~09	09~12	12~15	15~18	
기온 (°C)	5	3	0	-1	-2	0	1	0
날씨								
강수 확률	60 %	30 %	20 %	20 %	0 %	0 %	0 %	0 %
풍향 풍속 (m/s)	3-5	6-9	6-9	6-9	6-9	6-9	6-9	3-5
최고 최저 기온								아침최저 -2°C 낮최고 1°C

[20시 기상실황]					
현재날씨	현재기온 (°C)	풍향	풍속 (m/s)	일강수량 (mm)	신적설 (cm)
	8.1	WSW	3.0		



Parcel services without limits.

In time with business.



-

1.



1. 가

, (a)

(b)

(c)

(d)

(e)

1. 가

,

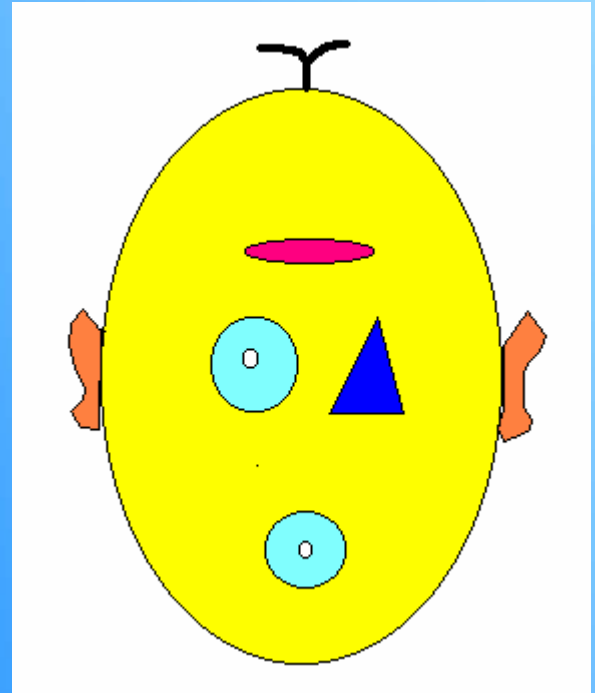
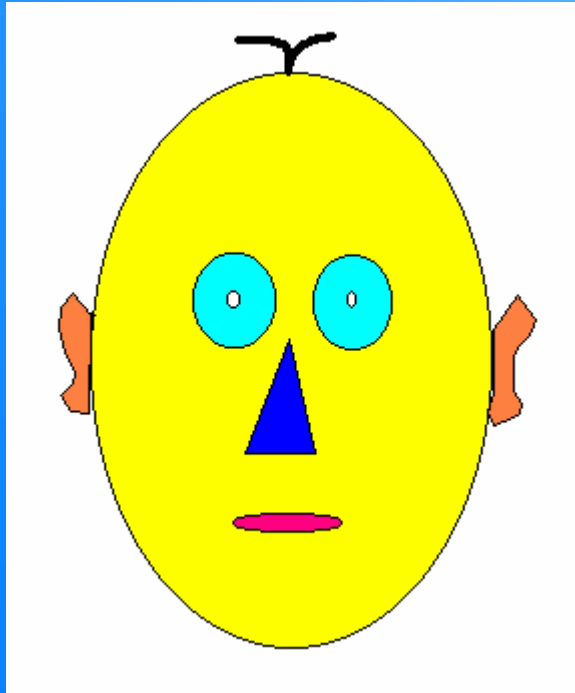

- :
- / / /
/ 가 /
-

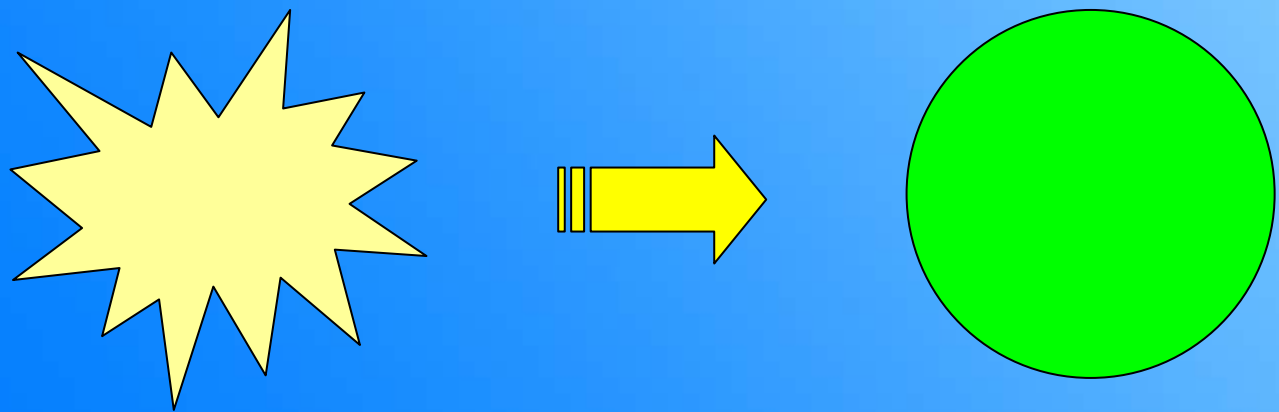

()



/



X

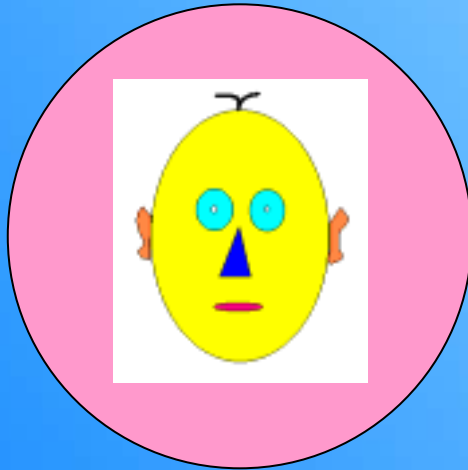

Y1 / Y2 / Y3



A

()

[Redacted]

$A + B + C$

vs

(가)

$A + B + C$

$A + B + C'$

$A + B + C + D$

$A + B + C' + D$

$A + B$

$a + B + C$

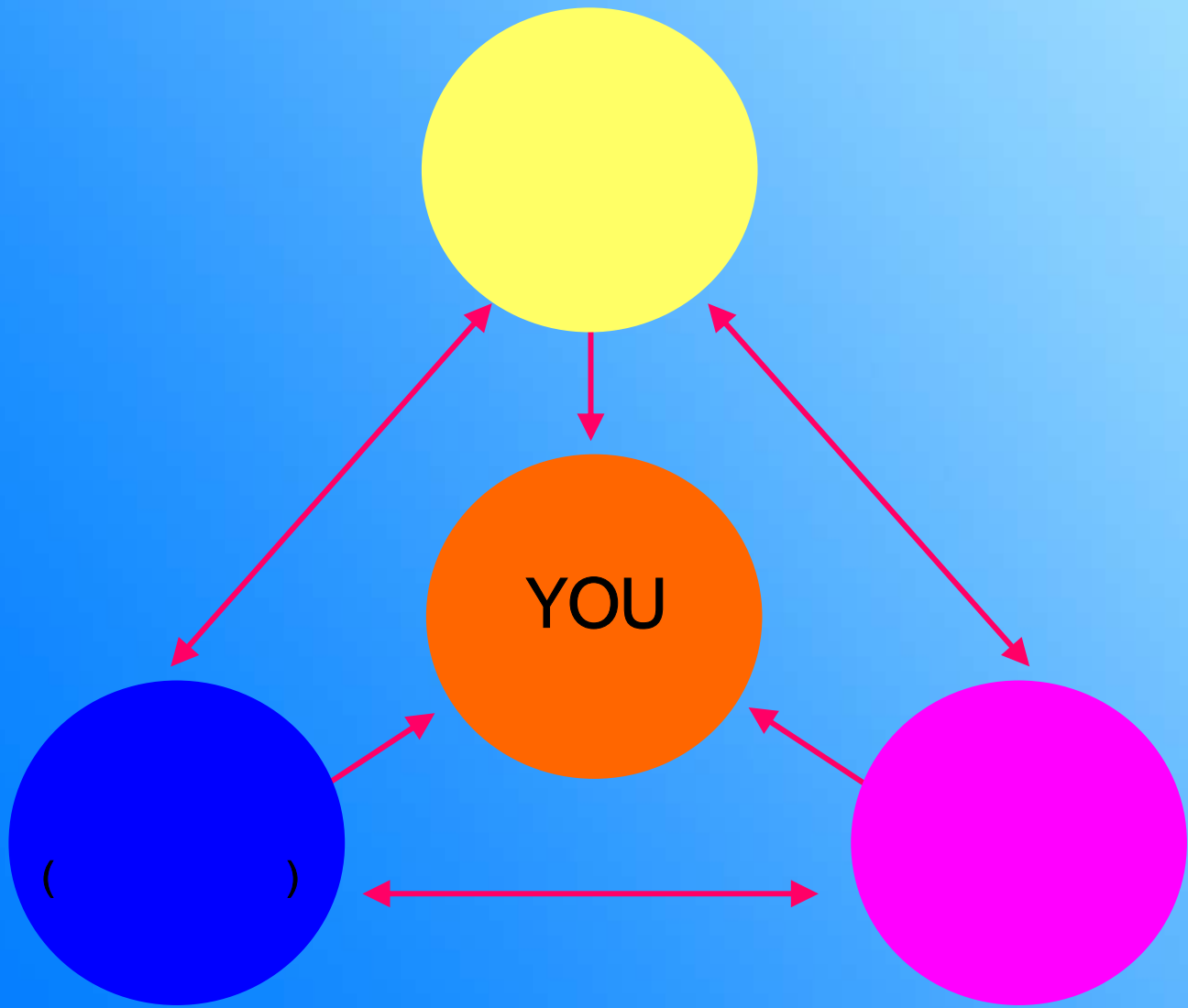

- ()

 -
 -
 -

- /

- 100%

 - 100% X, 80% Y, 50% Y



2

- 가 .
- (가)
- 가 ()
- GOOD to GREAT



THANK U