

**CHE302 LECTURE IX
FREQUENCY RESPONSES**

Professor Dae Ryook Yang

Fall 2001

**Dept. of Chemical and Biological Engineering
Korea University**

DEFINITION OF FREQUENCY RESPONSE

- **For linear system**
 - “The ultimate output response of a process for a sinusoidal input at a frequency will show amplitude change and phase shift at the same frequency depending on the process characteristics.”

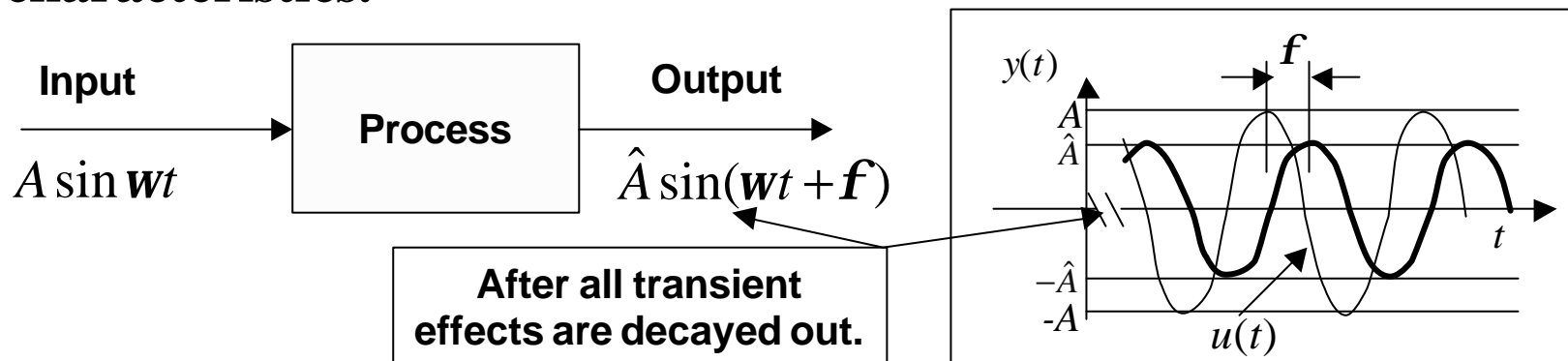

- **Amplitude ratio (AR):** attenuation of amplitude, \hat{A} / A
- **Phase angle (f):** phase shift compared to input
- **These two quantities are the function of frequency.**

BENEFITS OF FREQUENCY RESPONSE

- Frequency responses are the informative representations of dynamic systems

- Audio Speaker

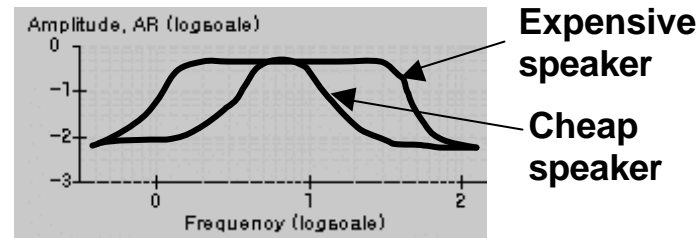

- Equalizer

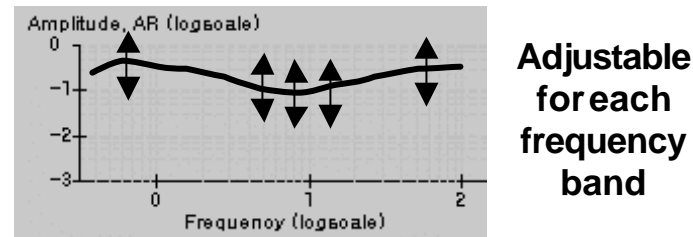
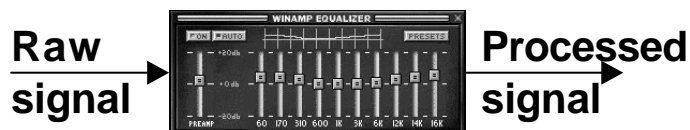

- Structure

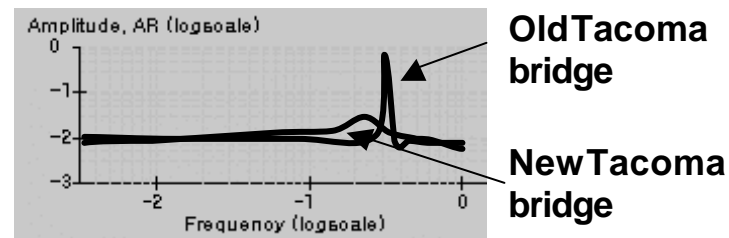
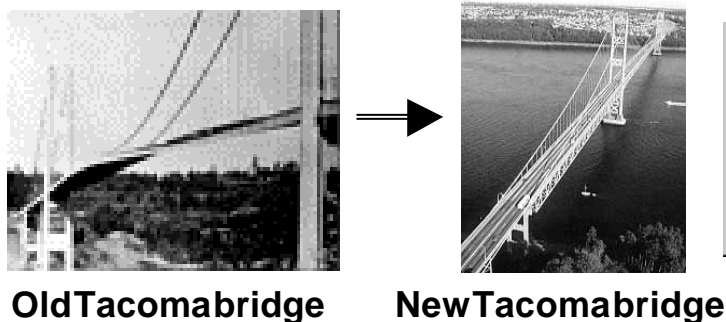

– **Low-pass filter**

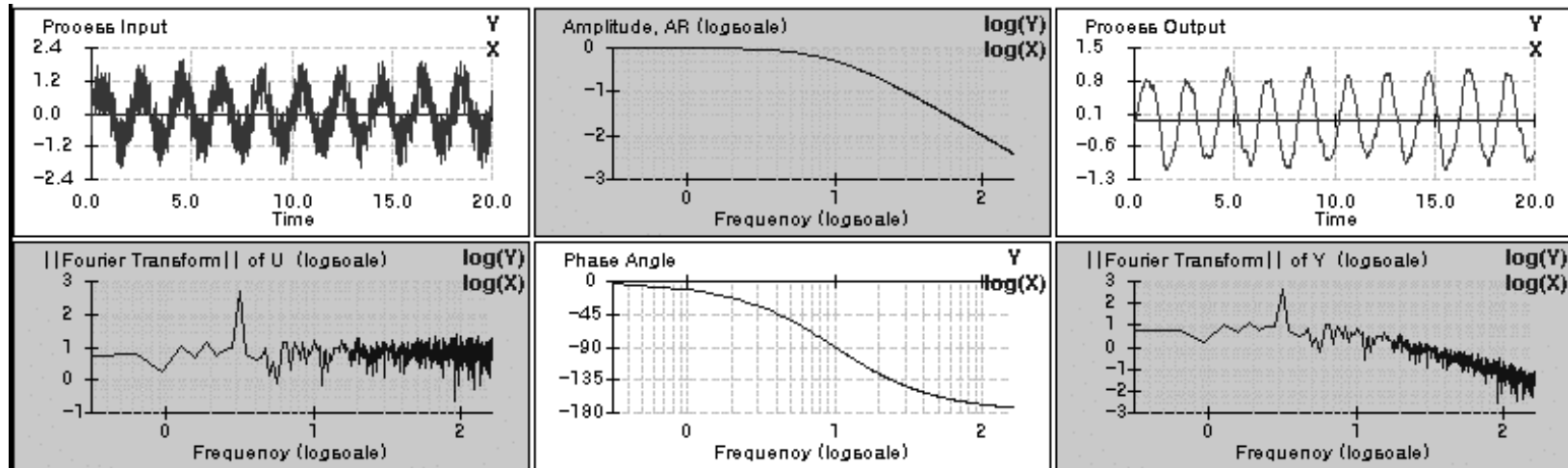

– **High-pass filter**

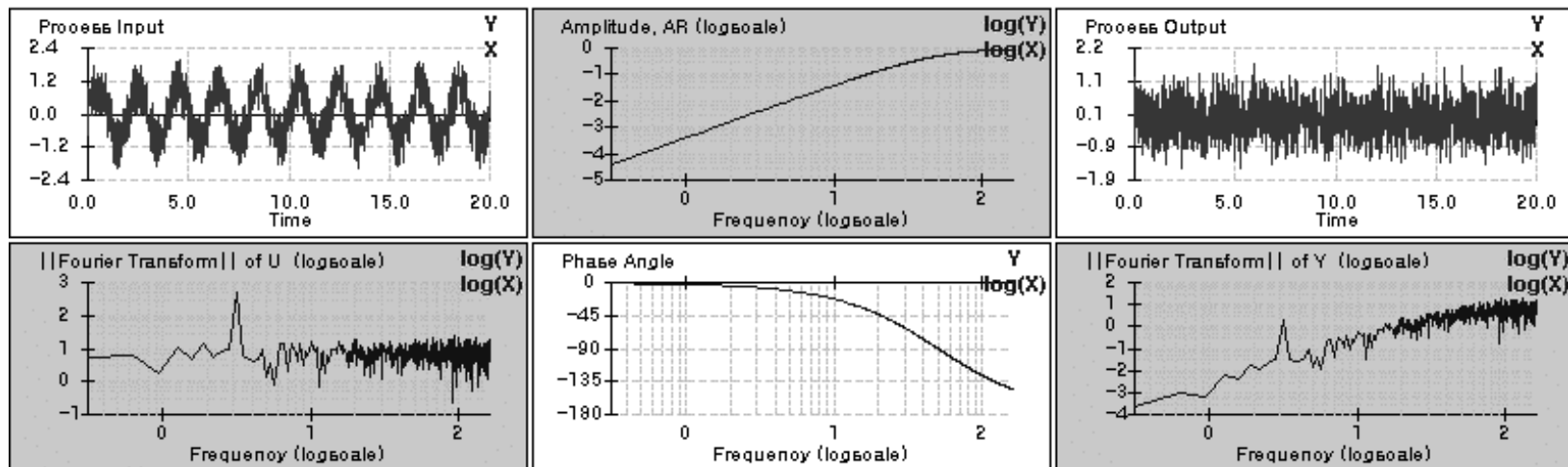

– **In signal processing field, transfer functions are called “filters”.**

- **Any linear dynamical system is completely defined by its frequency response.**
 - The AR and phase angle define the system completely.
 - Bode diagram
 - AR in log-log plot
 - Phase angle in log-linear plot
 - Via efficient numerical technique (fast Fourier transform, FFT), the output can be calculated for any type of input.
- **Frequency response representation of a system dynamics is very convenient for designing a feedback controller and analyzing a closed-loop system.**
 - Bode stability
 - Gain margin (GM) and phase margin (PM)

- **Critical frequency**

- As controller gain changes, the amplitude ratio (AR) and the phase angle (PA) change.
- The frequency where the PA reaches -180° is called critical frequency (ω_c).
- The component of output at the critical frequency will have the exactly same phase as the signal goes through the loop due to comparator (-180°) and phase shift of the process (-180°).
- For the open-loop gain at the critical frequency, $K_{OL}(\omega_c) = 1$
 - No change in magnitude
 - Continuous cycling
- For $K_{OL}(\omega_c) > 1$
 - Getting bigger in magnitude
 - Unstable
- For $K_{OL}(\omega_c) < 1$
 - Getting smaller in magnitude
 - Stable

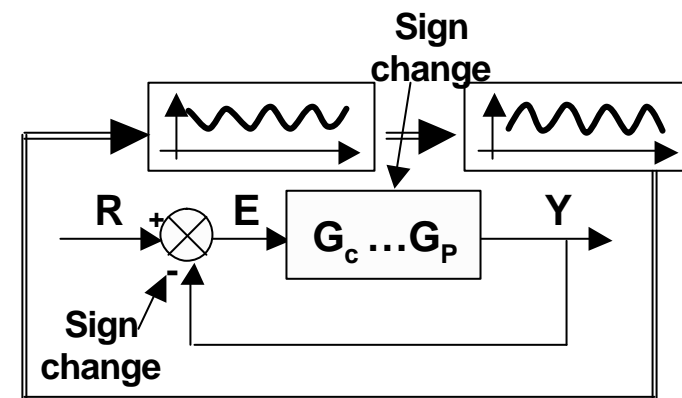

- **Example**

- If a feed is pumped by a peristaltic pump to a CSTR, will the fluctuation of the feed flow appear in the output?

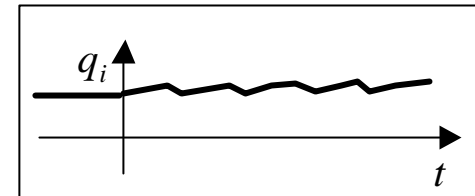
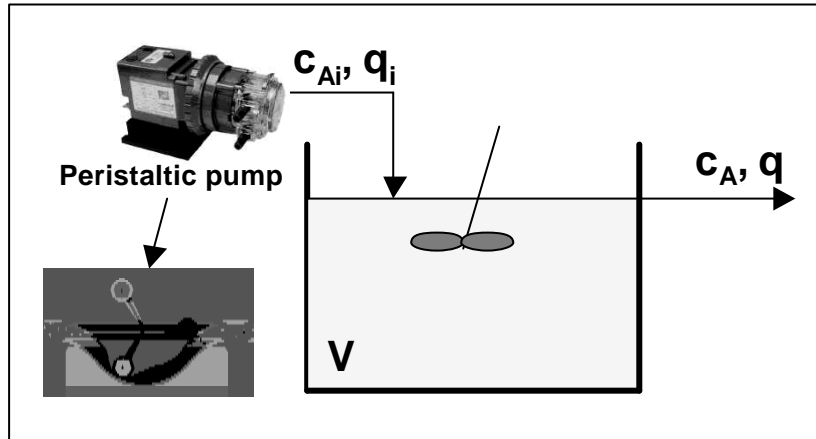

$$V \frac{dc_A}{dt} = q_i c_{Ai} - q c_A \quad (q \approx \text{constant})$$

$$\frac{C_A(s)}{q_i(s)} = \frac{C_{Ai}}{Vs + q} = \frac{C_{Ai}/q}{(V/q)s + 1}$$

- $V=50\text{cm}^3$, $q=90\text{cm}^3/\text{min}$ (so is the average of q_i)
 - Process time constant= 0.555min .
- The rpm of the peristaltic pump is 60rpm.
 - Input frequency= $180\text{rad}/\text{min}$ (3blades)
- The $AR=0.01$ ($\omega\tau = 100$)

If the magnitude of fluctuation of q_i is 5% of nominal flow rate, the fluctuation in the output concentration will be about 0.05% which is almost unnoticeable.

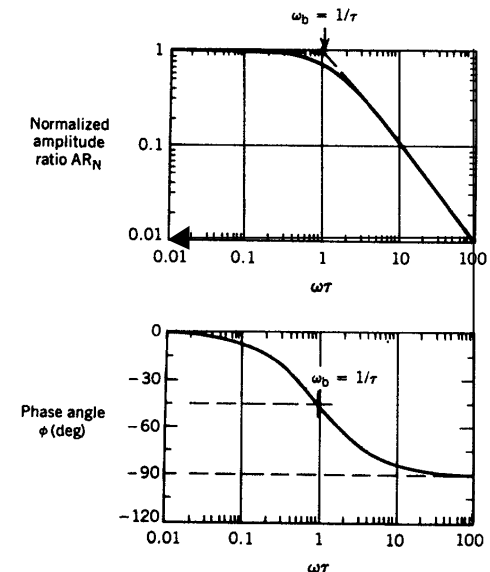

OBTAINING FREQUENCY RESPONSE

- From the transfer function, replace s with $j\omega$

$$\begin{array}{ccc}
 G(s) & \xrightarrow{s=j\omega} & G(j\omega) \\
 \uparrow & & \uparrow \\
 \text{Transfer function} & & \text{Frequency response}
 \end{array}$$

- For a pole, $s = a + j\omega$, the response mode is $e^{(a+j\omega)t}$.
- If the modes are not unstable ($a \leq 0$) and enough time elapses, the survived modes becomes $e^{j\omega t}$. (ultimate response)

- The frequency response, $G(j\omega)$ is complex as a function of frequency.

$$G(j\omega) = \text{Re}[G(j\omega)] + j \text{Im}[G(j\omega)]$$

$$AR = |G(j\omega)| = \sqrt{\text{Re}[G(j\omega)]^2 + \text{Im}[G(j\omega)]^2}$$

$$f = \angle G(j\omega) = \tan^{-1}(\text{Im}[G(j\omega)] / \text{Re}[G(j\omega)])$$

→ Bode plot

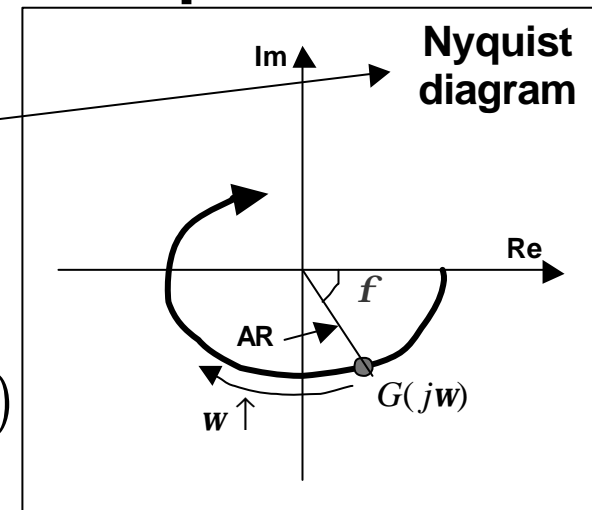

- **Getting ultimate response**

- For a sinusoidal forcing function $Y(s) = G(s) \frac{Aw}{s^2 + \omega^2}$
- Assume $G(s)$ has stable poles b_i .

$$Y(s) = G(s) \frac{Aw}{s^2 + \omega^2} = \frac{a_1}{s + b_1} + \dots + \frac{a_n}{s + b_n} + \frac{Cs + D\omega}{s^2 + \omega^2}$$

Decayed out at large t

$$G(j\omega)Aw = Cj\omega + D\omega \Rightarrow G(j\omega) = \frac{D}{A} + j\frac{C}{A} = R + jI$$

$$C = IA, D = RA \Rightarrow y_{ul} = A(I \cos \omega t + R \sin \omega t) = \hat{A} \sin(\omega t + f)$$

$$\therefore AR = \hat{A} / A = \sqrt{R^2 + I^2} = |G(j\omega)| \text{ and } f = \tan^{-1}(I / R) = \angle G(j\omega)$$

- Without calculating transient response, the frequency response can be obtained directly from $G(j\omega)$.
- Unstable transfer function does not have a frequency response because a sinusoidal input produces an unstable output response.

- **First-order process**

$$G(s) = \frac{K}{(\tau s + 1)}$$

$$G(j\omega) = \frac{K}{(1 + j\omega\tau)} = \frac{K}{(1 + \omega^2\tau^2)} (1 - j\omega\tau)$$

$$AR_N = |G(j\omega)| = \frac{1}{\sqrt{1 + \omega^2\tau^2}}$$

$$\angle G(j\omega) = -\tan^{-1}(\omega\tau)$$

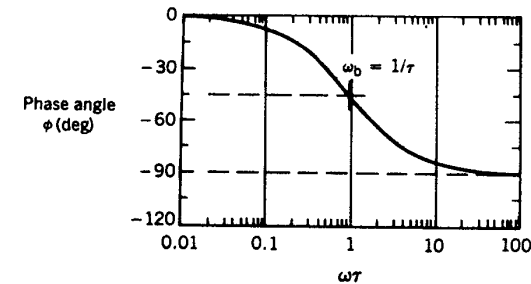
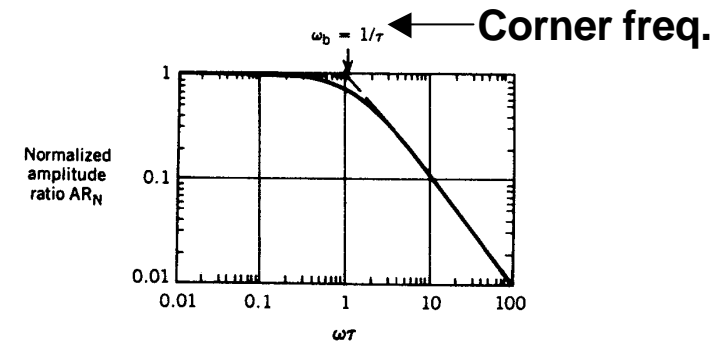

- **Second-order process**

$$G(s) = \frac{K}{(\tau^2 s^2 + 2z\tau s + 1)}$$

$$G(j\omega) = \frac{K}{(1 - \tau^2\omega^2) + 2jz\tau\omega}$$

$$AR = |G(j\omega)| = \frac{K}{\sqrt{(1 - \omega^2\tau^2)^2 + (2z\omega\tau)^2}}$$

$$\angle G(j\omega) = \tan^{-1} \frac{\text{Im}(G(j\omega))}{\text{Re}(G(j\omega))} = -\tan^{-1} \frac{2z\omega\tau}{1 - \omega^2\tau^2}$$

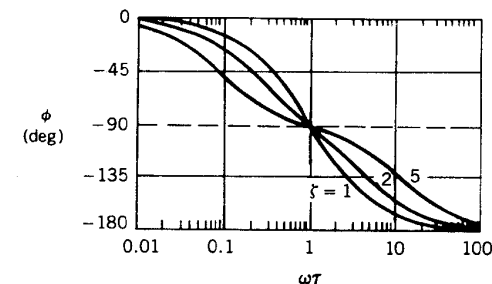
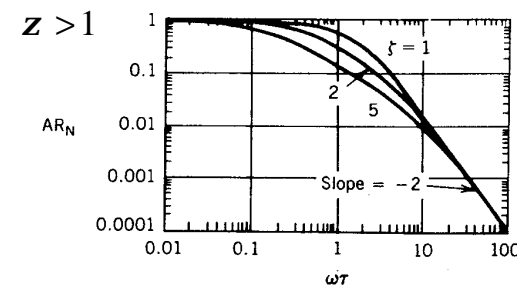

- **Process Zero (lead)**

$$G(s) = t_a s + 1$$

$$G(j\omega) = 1 + j\omega t_a$$

$$AR_N = |G(j\omega)| = \sqrt{1 + \omega^2 t_a^2}$$

$$f = \angle G(j\omega) = \tan^{-1}(\omega t_a)$$

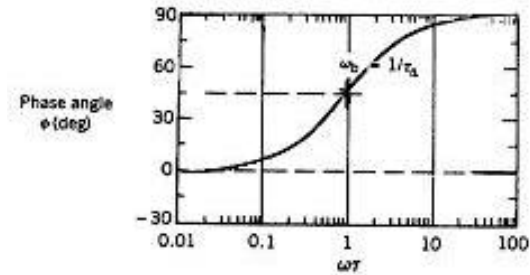
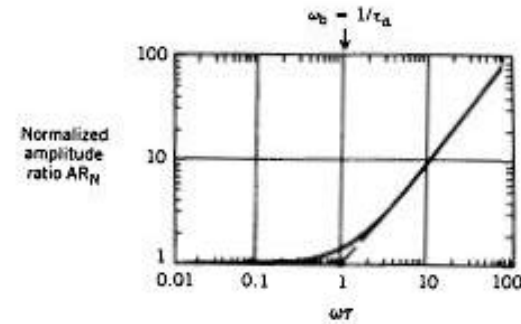

- **Unstable pole**

$$G(s) = \frac{1}{(-ts + 1)}$$

$$G(j\omega) = \frac{1}{1 - j\omega t} = \frac{1}{1 + t^2 \omega^2} (1 + j\omega t)$$

$$AR = |G(j\omega)| = \frac{1}{\sqrt{1 + \omega^2 t^2}}$$

$$f = \angle G(j\omega) = \tan^{-1} \frac{\text{Im}(G(j\omega))}{\text{Re}(G(j\omega))} = \tan^{-1} \omega t$$

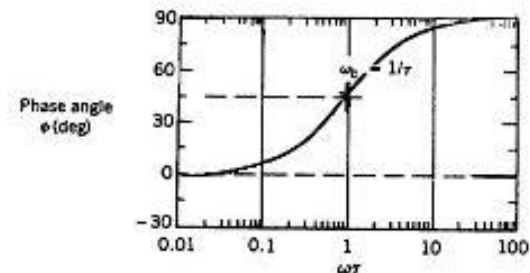
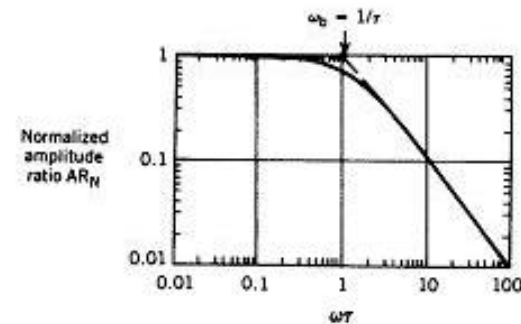

- **Integrating process**

$$G(s) = \frac{1}{As} \quad G(j\omega) = \frac{1}{jA\omega} = -\frac{1}{A\omega} j$$

$$AR_N = |G(j\omega)| = \frac{1}{A\omega}$$

$$f = \angle G(j\omega) = \tan^{-1}\left(-\frac{1}{0 \cdot \omega}\right) = -\frac{p}{2}$$

- **Differentiator**

$$G(s) = As \quad G(j\omega) = jA\omega$$

$$AR_N = |G(j\omega)| = A\omega$$

$$f = \angle G(j\omega) = \tan^{-1}\left(\frac{1}{0 \cdot \omega}\right) = \frac{p}{2}$$

- **Pure delay process**

$$G(s) = e^{-qs}$$

$$G(j\omega) = e^{-jq\omega} = \cos q\omega - j \sin q\omega$$

$$AR = |G(j\omega)| = 1$$

$$f = \angle G(j\omega) = -\tan^{-1} \tan q\omega = -q\omega$$

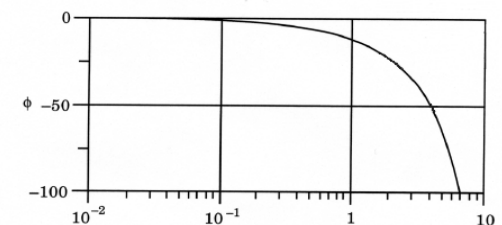
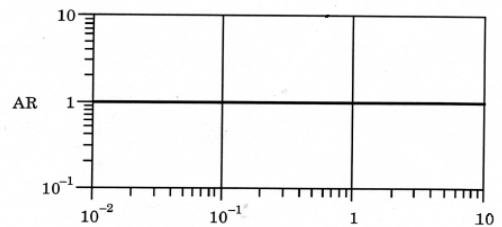
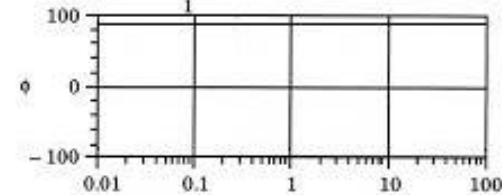
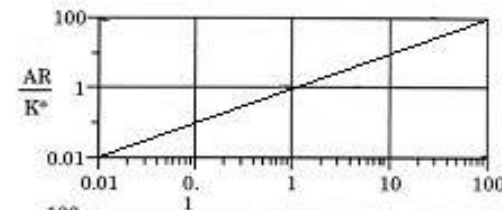
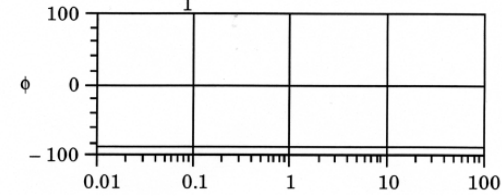
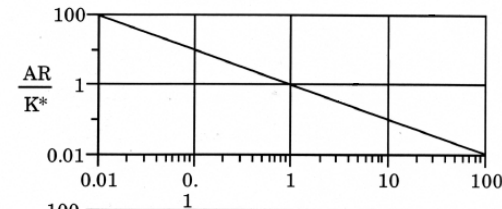

SKETCHING BODE PLOT

$$G(s) = \frac{G_a(s)G_b(s)G_c(s)\cdots}{G_1(s)G_2(s)G_3(s)\cdots} \quad G(j\omega) = \frac{G_a(j\omega)G_b(j\omega)G_c(j\omega)\cdots}{G_1(j\omega)G_2(j\omega)G_3(j\omega)\cdots}$$

$$|G(j\omega)| = \frac{|G_a(j\omega)||G_b(j\omega)||G_c(j\omega)|\cdots}{|G_1(j\omega)||G_2(j\omega)||G_3(j\omega)|\cdots}$$

$$\angle G(j\omega) = \angle G_a(j\omega) + \angle G_b(j\omega) + \angle G_c(j\omega) + \cdots \\ - \angle G_1(j\omega) - \angle G_2(j\omega) - \angle G_3(j\omega) - \cdots$$

- **Bode diagram**

- AR vs. frequency in log-log plot
- PA vs. frequency in semi-log plot
- Useful for
 - Analysis of the response characteristics
 - Stability of the closed-loop system only for open-loop stable systems with phase angle curves exhibit a single critical frequency.

- **Amplitude Ratio on log-log plot**
 - Start from steady-state gain at $w = 0$. If G_{OL} includes either integrator or differentiator it starts at ∞ or 0 .
 - Each first-order lag (lead) adds to the slope -1 ($+1$) starting at the corner frequency.
 - Each integrator (differentiator) adds to the slope -1 ($+1$) starting at zero frequency.
 - A delay does not contribute to the AR plot.
- **Phase angle on semi-log plot**
 - Start from 0° or -180° at $w = 0$ depending on the sign of steady-state gain.
 - Each first-order lag (lead) adds 0° to phase angle at $w = 0$, adds -90° ($+90^\circ$) to phase angle at $w = \infty$, and adds -45° ($+45^\circ$) to phase angle at corner frequency.
 - Each integrator (differentiator) adds -90° ($+90^\circ$) to the phase angle for all frequency.
 - A delay adds $-qw$ to phase angle depending on the frequency.

Examples

$$1. G(s) = \frac{K}{\underbrace{(10s+1)}_{G_1} \underbrace{(5s+1)}_{G_2} \underbrace{(s+1)}_{G_3}}$$

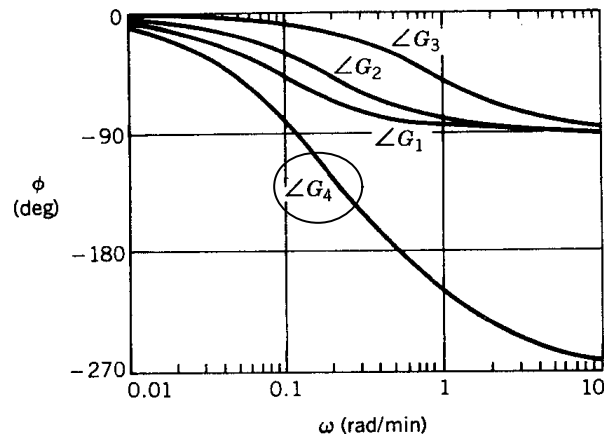
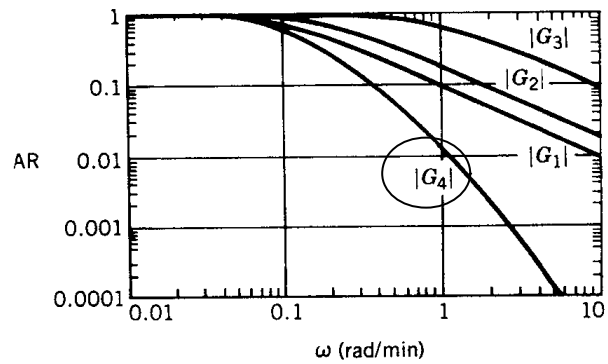

$$2. G(s) = \frac{\underbrace{5}_{G_1} \underbrace{(0.5s+1)}_{G_5} \underbrace{e^{-0.5s}}_{G_4}}{\underbrace{(20s+1)}_{G_2} \underbrace{(4s+1)}_{G_3}}$$

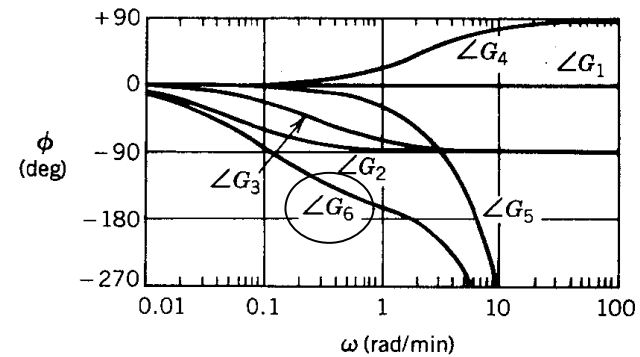
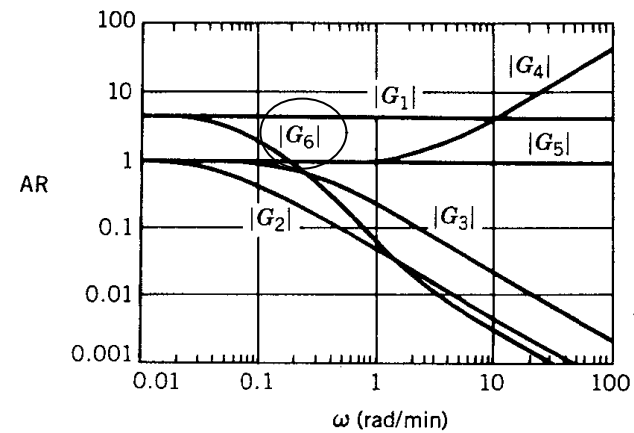

3. PI: $G(s) = K_C \left(1 + \frac{1}{t_I s} \right)$

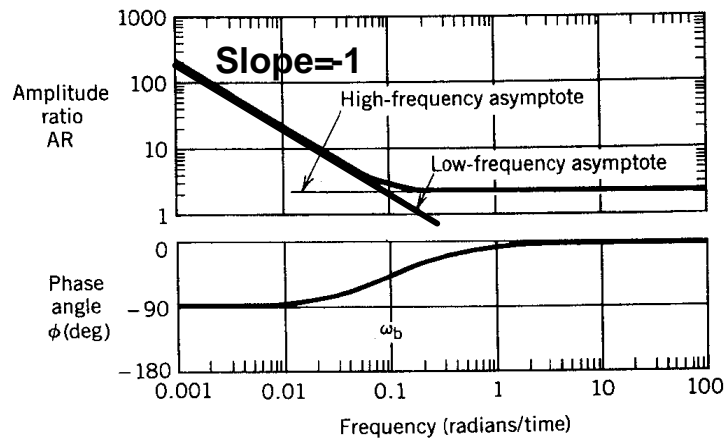

$\omega_b = 1/t_I$ at $f = -45^\circ$

5. PID: $G(s) = K_C \left(1 + \frac{1}{t_I s} + t_D s \right)$

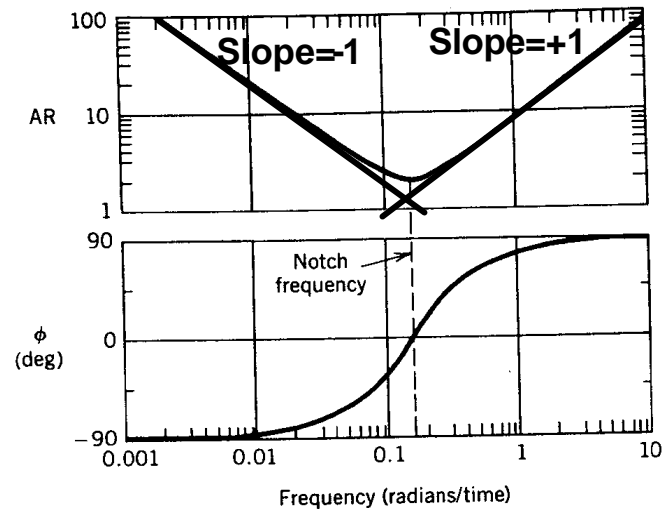

$\omega_{Notch} = 1/\sqrt{t_I t_D}$ at $f = 0^\circ$

4. PD: $G(s) = K_C (1 + t_D s)$

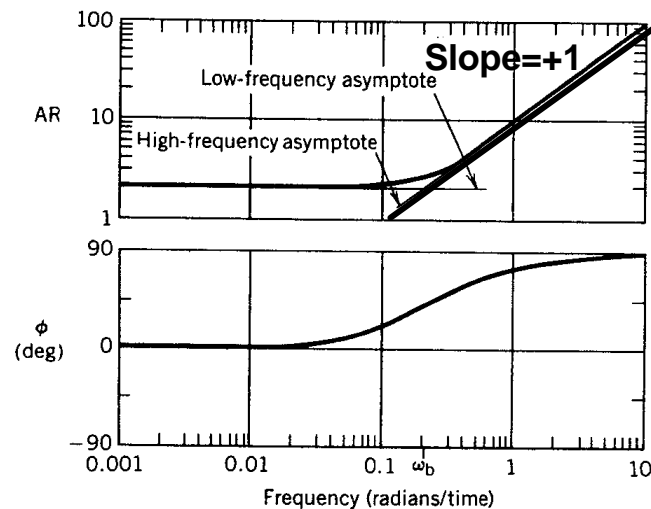

$\omega_b = 1/t_D$ at $f = +45^\circ$

NYQUIST DIAGRAM

- **Alternative representation of frequency response**
- **Polar plot of $G(j\omega)$ (ω is implicit)**

$$G(j\omega) = \text{Re}[G(j\omega)] + j \text{Im}[G(j\omega)]$$

- **Compact (one plot)**
- **Wider applicability of stability analysis than Bode plot**
- **High frequency characteristics will be shrunk near the origin.**
 - **Inverse Nyquist diagram: polar plot of $1/G(j\omega)$**
- **Combination of different transfer function components is not easy as with Nyquist diagram as with Bode plot.**

