



# **Performance of Valence's Lithium Ion Polymer Battery**

**R.J. Brodd and J.L. Morris  
Valence Technology, Inc.**

**December 12-13, 1996**



# Product Focus



■ Premium Portable Products

■ High Energy Density

■ Prismatic Packaging

■ Design Flexibility

■ Cost Reduction



# Products Targeted



- Cellular Telephones
- Laptop/Notebook Computers
- Personal Digital Assistants
- Camcorders



# Battery Chemistry



■ Rocking Chair Chemistry

■ High Energy Density

■ High Unit Cell Voltage

■ Solid Polymer Electrolyte

■ Low Cost Materials



# Cell Operation

## Rocking Chair Concept

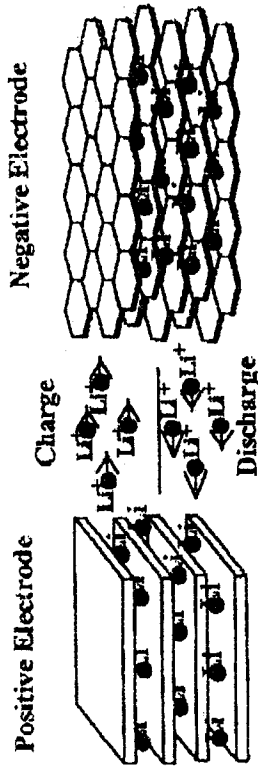



# Schematic Unit Cell

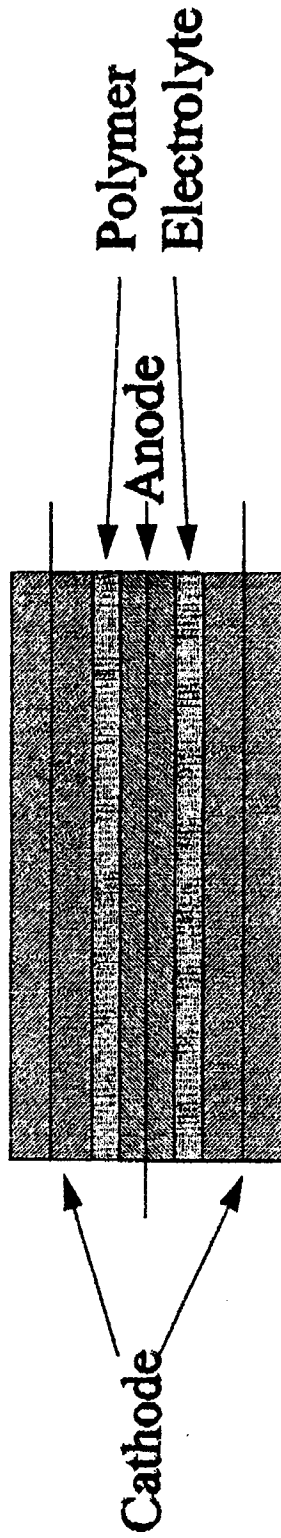



# Typical Charge/Discharge Curve

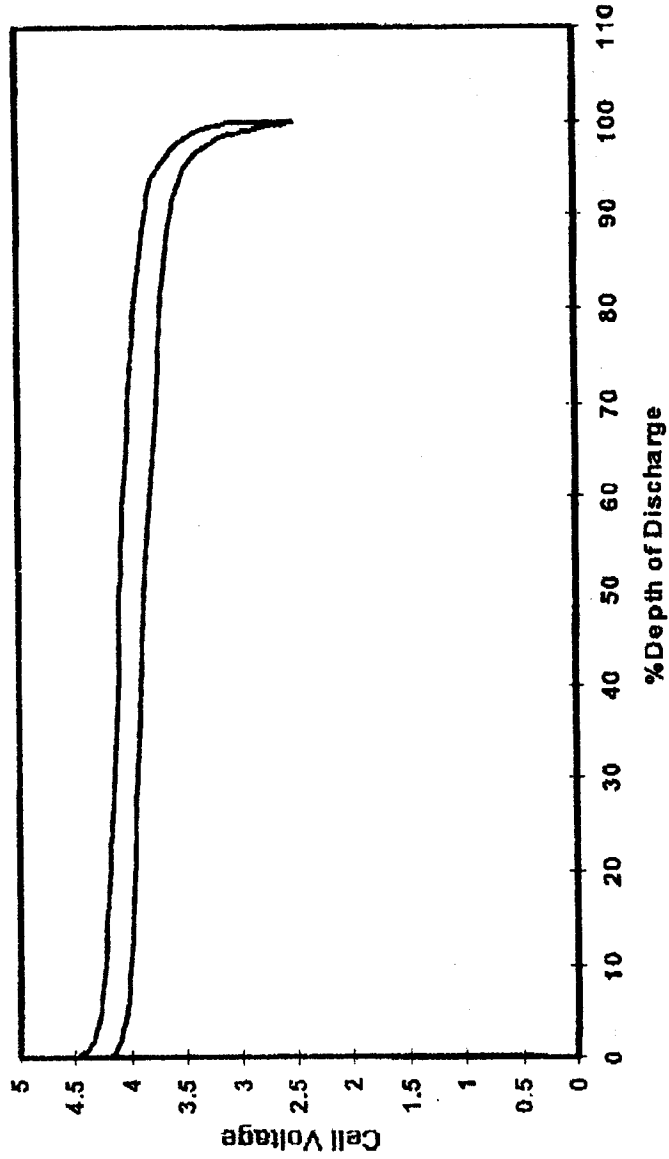



# “Signature” Curve

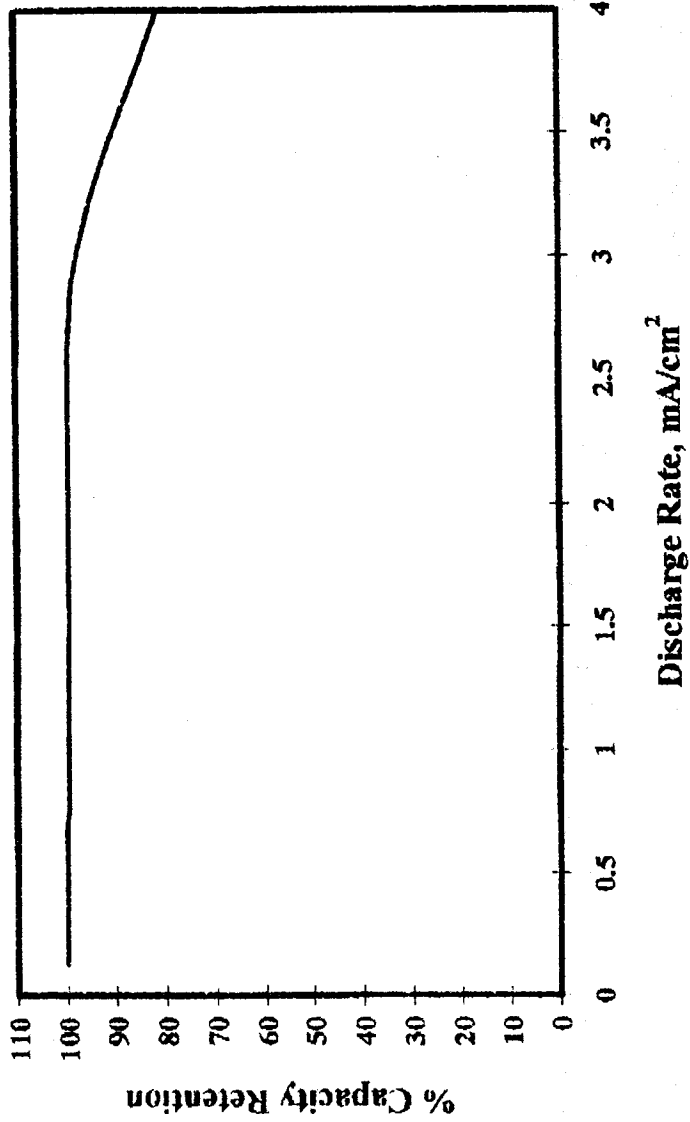





# Voltage vs. Discharge Rate

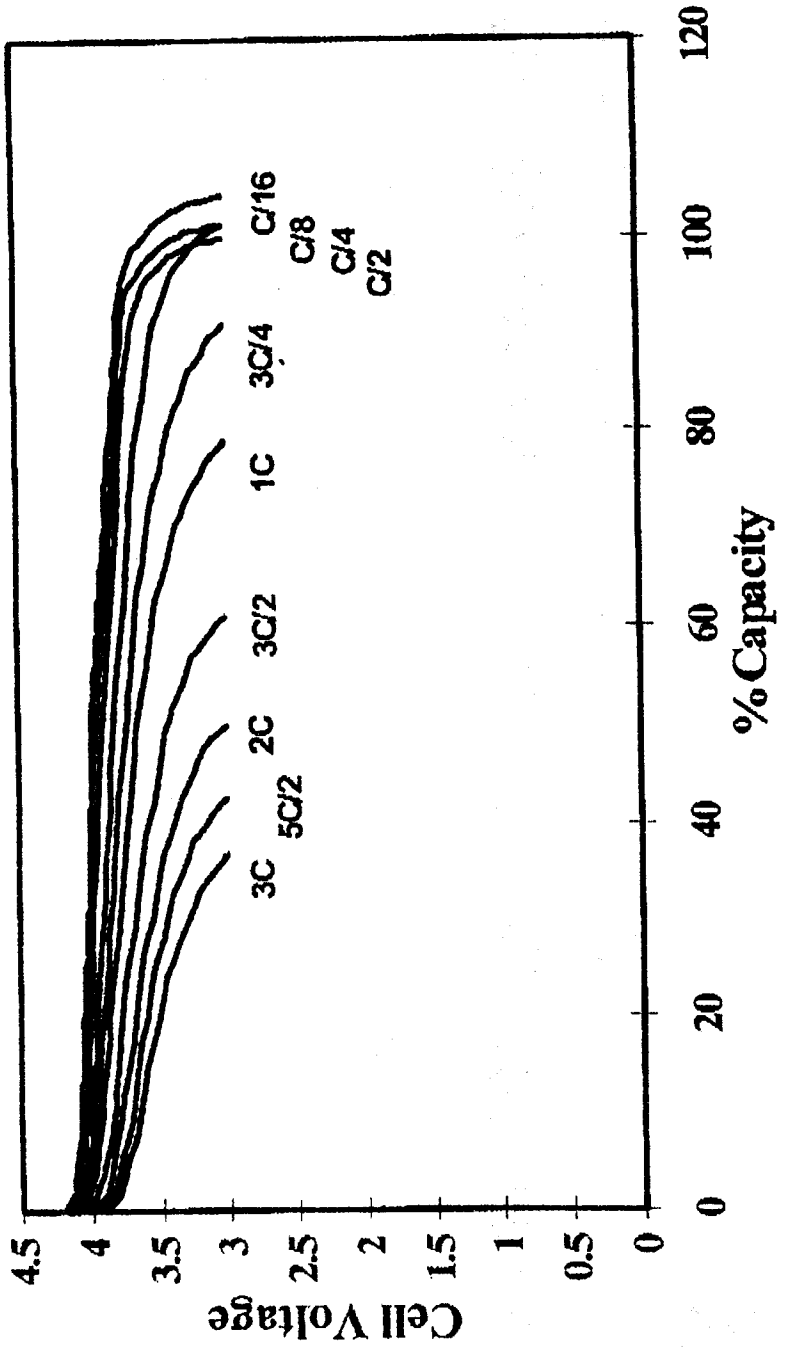



# Pulse Power Performance

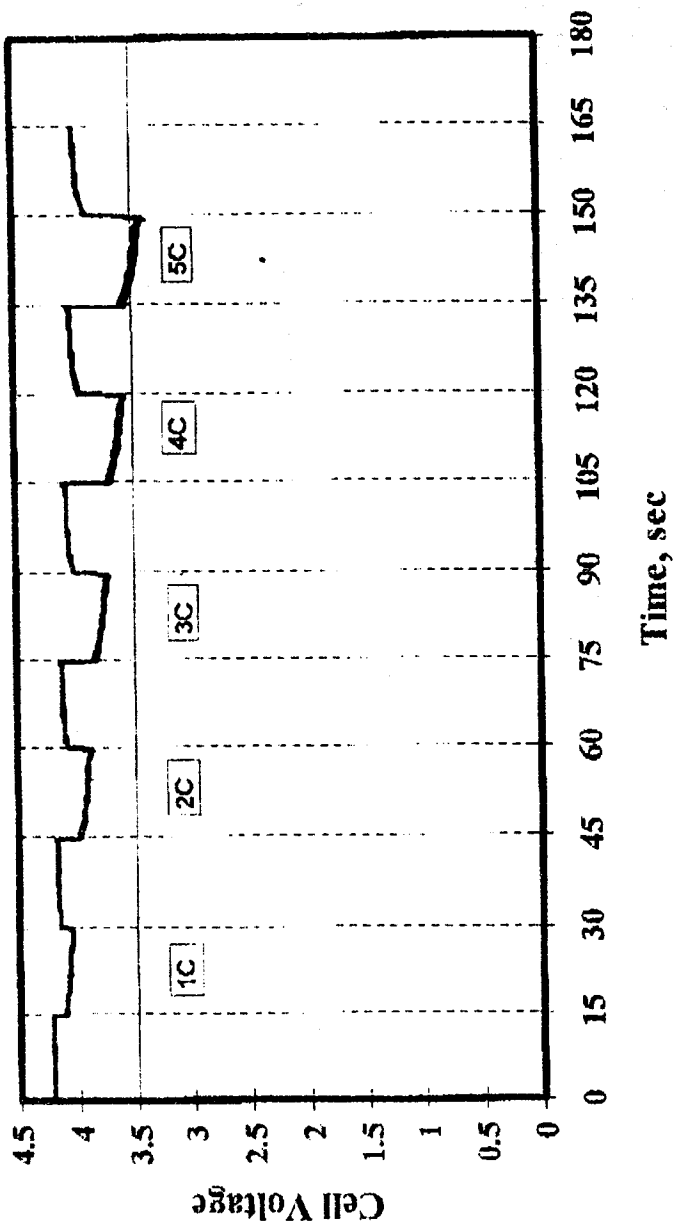

# Cycling Performance at 100% DOD

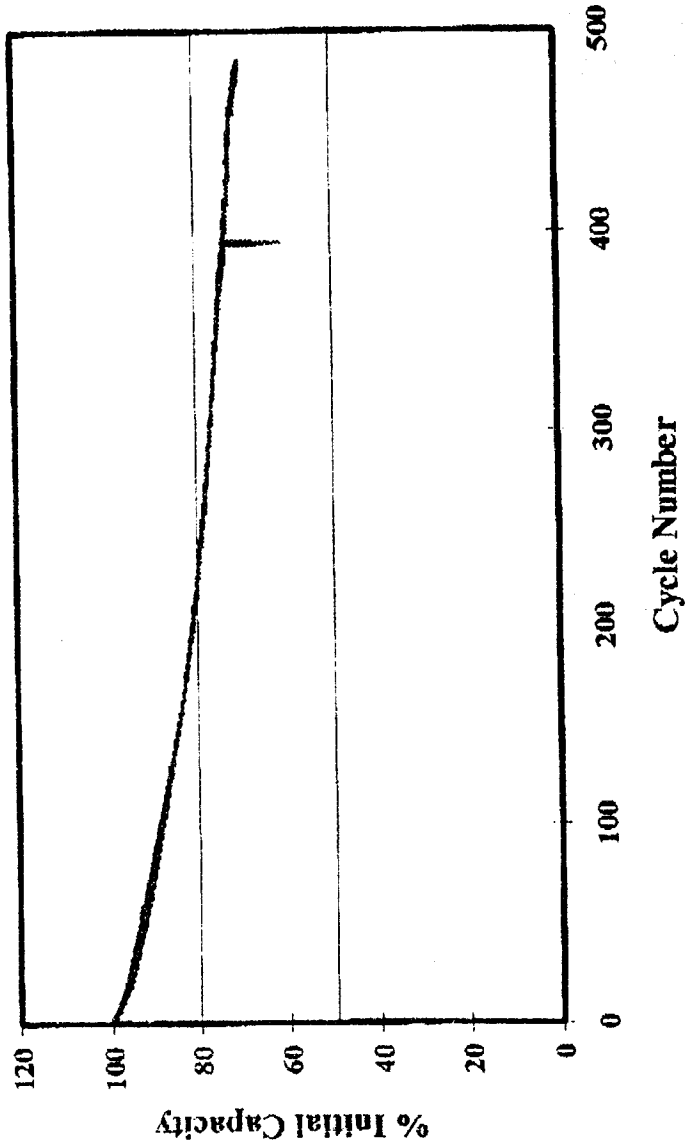



# Initial Product Design

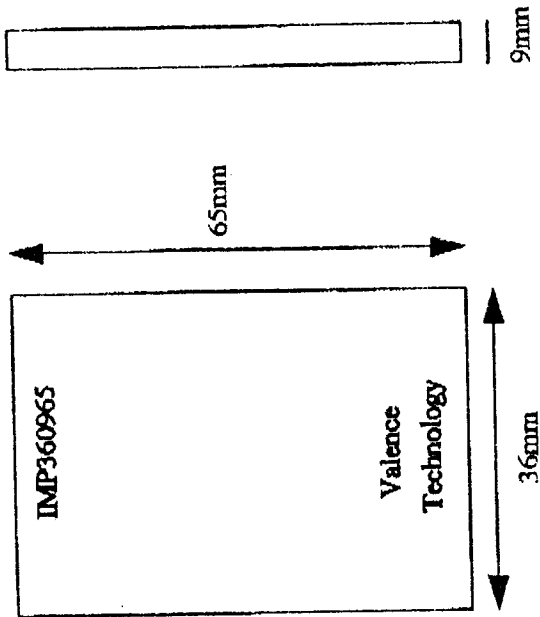



# Product Design Strategy

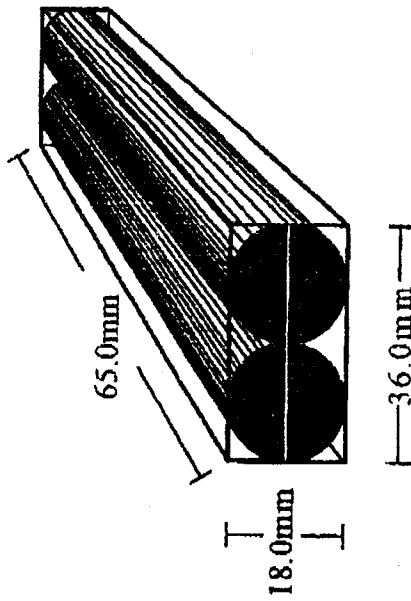

2 x IMP360965

# Computer Battery Design Concept

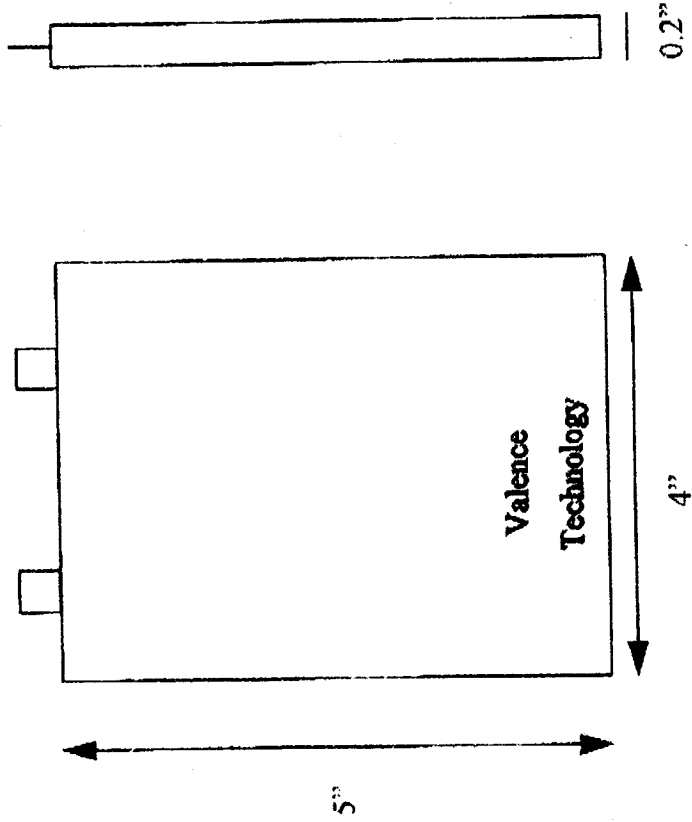



# Valence Technology



- Founded 1989
- Henderson, NV
- Mallusk, Northern Ireland
- Hanil Valence, Korea
- Valtron, Singapore
- Delphi Energy Systems



# Summary



- Technology Established
- Cell Designs Selected
- Markets Identified
- Partnerships Established
- Production Plans Proceeding